

RADIO

REG. U.S. PAT. OFF.

WORLD

The First National Radio Weekly
638th Consecutive Issue Thirteenth Year

Converter Diagrams

TUNING CURVES FOR
BUD CONDENSER
AND ALDEN COILS

Test Oscillator with 34

Front Panel Plug-in Coils in Short-Wave Set

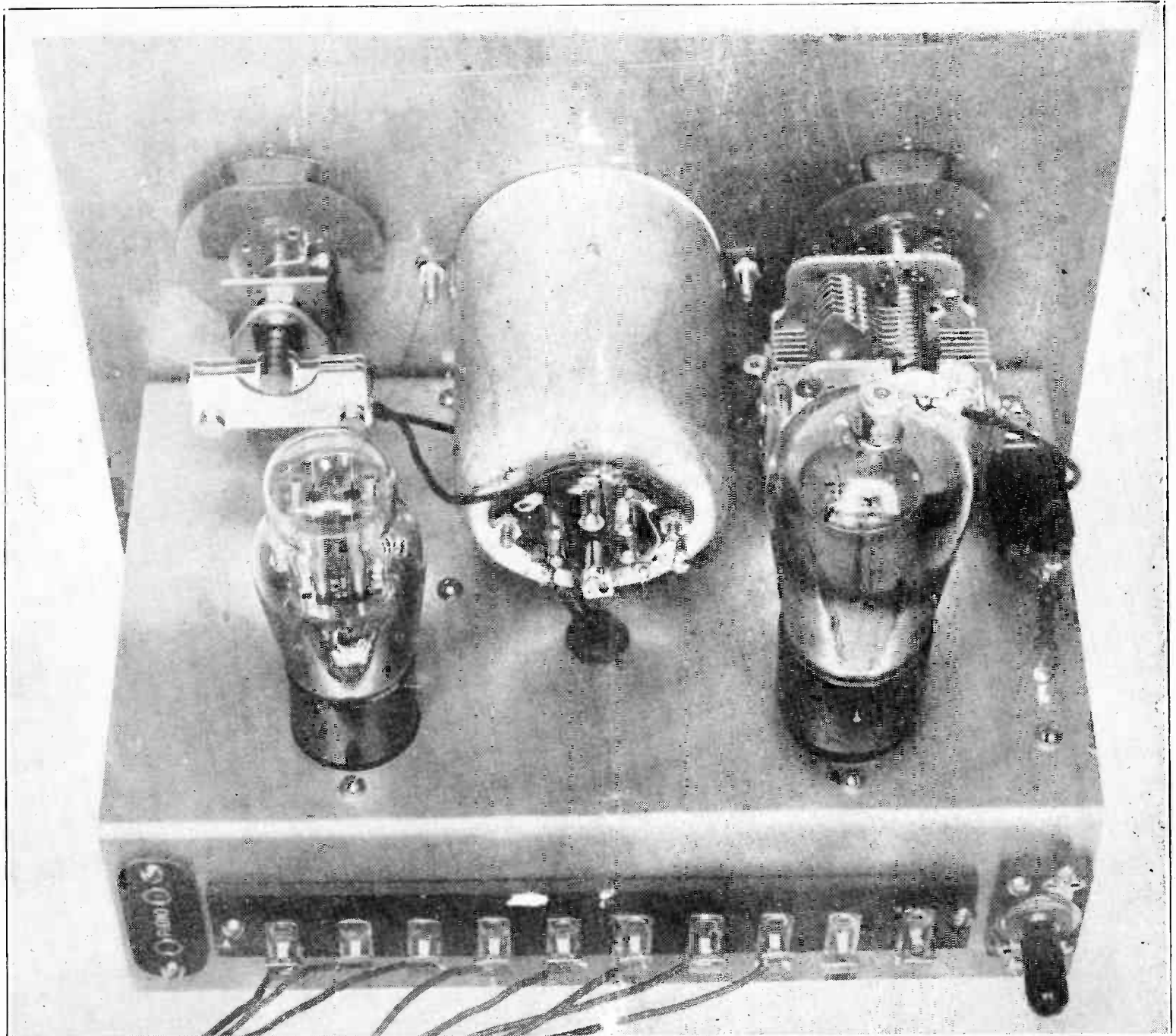

June 16
1934

The 32 is the detector in this battery-operated set, and the twin tube, 19, is used for audio, thus giving three-tube performance. See article on page 19.



15c
Per Copy

1,650 to 3,620 Kc Chart for Bud 0.00014 Mfd. and Green-Ringed Alden Plug-in Coil

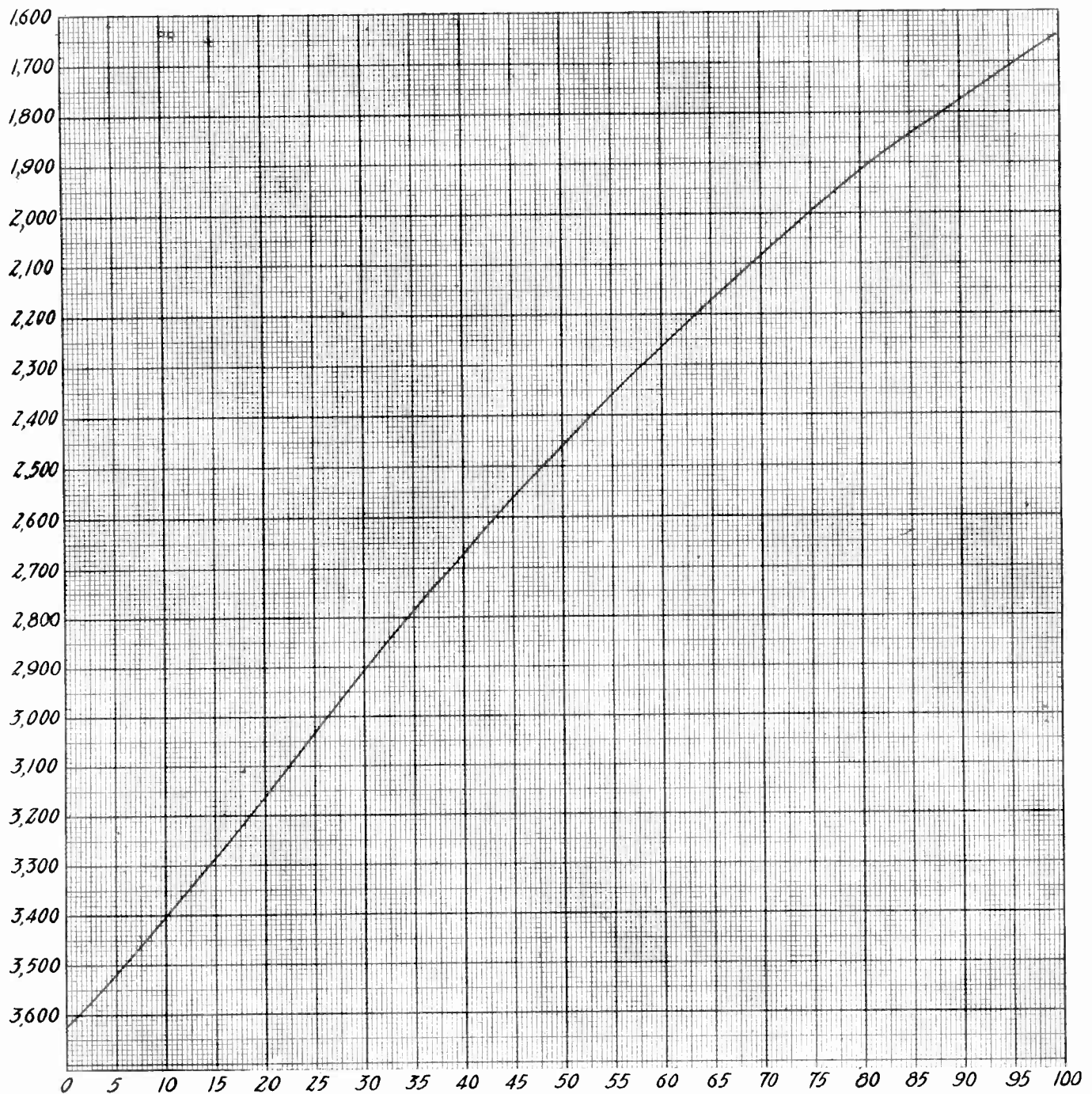

The dial represents higher capacity of the tuning condenser, or lower frequencies, for higher numerical values. This tuning curve will be closely approximated in any oscillator using these parts. The coils are commercially wound. The condenser is of the large frame type, not the single-hole panel mounting type.

Charts are one of the best means of showing concretely the relationship of two or more independent variables. Thus in the tuning process, for a constant inductance, the two variables are the capacity and the dial settings. However, the capacity is not of paramount interest. What one does concern himself about is the frequency, because the transmitting stations operate on assigned frequencies, not on assigned capacities. The variations in dial settings obtain under all systems, or the equivalent of such variation is present.

Estimating Between Lines

The dial has calibrations of numerical values from 100 to 0 or 0 to 100. If one desires to use the same constants as were present in the device with which the calibration was run, he will be able to duplicate the curve, but the dial may read in the wrong direction. In that instance, subtract the dial number on the curve from 100, which is equivalent to reversing the direction of the dial motion, or reversing the numbers on the dial.

Some experimenters regard curves as things too technical for them to consider, but this is a mistake, as the curve is simpler than a tabulation, and besides allows reading integral values. For instance, when high frequencies are calibrated, horizontal lines may represent frequency differences of 100 kc, but it is possible to estimate to 50 or even 33 or 25 kc, and the eye is quite keen at this work.

Oscillator More Tractable

In short-wave reception it is well to have a station finder, if it is accurate, even for use as a complement to a frequency-calibrated dial. It is easier to make the oscillator calibration accurate and permanent than the receiver calibration, and besides the small differences in frequencies, either not shown on the frequency-calibrated scale of a set dial, or, if shown, not present with sufficient accuracy, are spotted readily.

For low frequencies the plotting is always easy enough, and
(Continued on page 13)

An Exclusive Powertone Feature! THE "COSMAN TWO"

The "Cosman Two" Battery - Operated Short Wave features a coil rack that holds five plug-in coils. This idea eliminates the old fashioned searching for the desired coil. The coils are easily placed in their respective order.

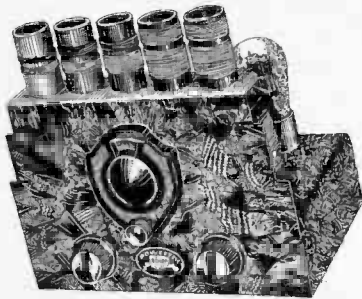

Another remarkable feature is that even though the "Cosman Two" is only a two tube set, it will work a loud speaker at an unusual volume. Foreign stations as well as domestic short waves come in on the loud speaker.

At last loudspeaker reception on two new (2 volt) tubes. Ease of construction is but one of the many new features which is found in this radically new short and long wave receiver. An exclusive idea, makes this one of the many outstanding short wave ideas which are developed for the inexperienced as well as the dyed in wool short wave fans.

- Complete kit of parts (including 4 Bruno junior plug-in coils) 15-200 meters \$5.95
- Bruno Broadcast Coil (200-550 meters)39
- Kit of R.C.A. licensed tubes, 1-32, 1-33 1.95
- Wired and tested. Extra 1.00

RELIABLE RADIO CO., 143 W. 45th St., New York City

ANNOUNCING

Two NEW and BETTER Tube Testers!

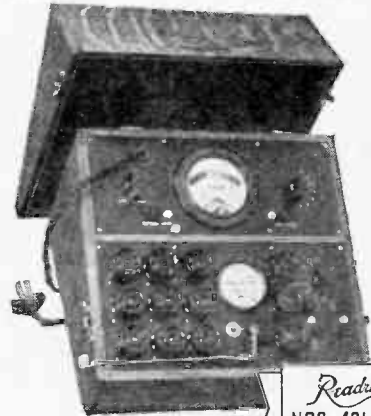

Readrite NOS. 421-422

READRITE announces two new and better tube testers: the No. 421, for the dealer's counter—and the No. 422, a portable unit for the service man . . . out in the field. These improved testers are characterized by many unusual and outstanding features that give a new conception of tube tester performance. They are so simply designed that anyone, without experience, can operate and understand them.

These testers incorporate a 3 1/2" Triplett Precision Meter, which has a shaded two-color scale. It indicates in simple English that the condition of the tube is either "good" or "poor." No longer need you reassure skeptical customers as to the worth of tubes that you are testing for them.

A line voltage control A.C. Meter is also incorporated, which tests cathode and grid shorts. A simple push button provides two-plate current readings for determining the worth and conductance of all types of new and old tubes.

Your Jobber Can Supply You

. . . with the No. 421 (counter tester) at the dealer's net price of \$24.00—and with the No. 422 (portable tester), at the dealer's net price of \$25.50. These testers come in a beautiful quarter-sawed oak case.

Readrite Meter Works

119 College Ave.

Bluffton, Ohio



SEND COUPON FOR FACTS!

READRITE METER WORKS,
119 College Ave., Bluffton, Ohio.

Gentlemen:

Send me a catalog on Readrite Tube Testers, and your complete line of radio servicing equipment.

Name

Address

City State

ALL ELECTRIC All-Wave Air Scout

Only set of its kind in the world

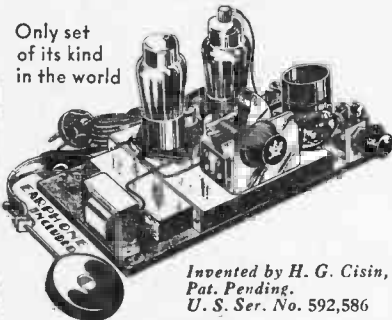

Invented by H. G. Cisin, Pat. Pending. U. S. Ser. No. 592,586

This powerful little set operates directly from any house lighting circuit, either a.c. or d.c. It brings in all standard broadcast stations and also police calls, foreign stations, code and trans-Atlantic phone conversations. Uses five plug-in coils to cover band from 10 to 550 meters. Compact and light—makes an ideal portable. Will operate several head-sets simultaneously and will work on a short indoor aerial.

Complete set, with two tubes, earphone, two coils covering band from 70 to 550 meters, ready to plug in and use. Postpaid \$8.50

Same as above, less earphones. Postpaid \$8.00

Three extra plug-in coils to cover band from 10 to 70 meters—50c each.

NOTE: All Electric Air Scout not available in Kit Form.

SPECIAL OFFER: Valuable data on All-Wave Receivers sent upon receipt of 10c to cover handling costs. Free circulars also available.

RELIABLE RADIO CO.
143 W. 45th St. New York

BUD POLICE THRILLER and SHORT WAVE ADAPTER

Get Police Calls

On Your Present Radio With

BUD POLICE THRILLER

Fits Any Electric Radio—Easy to Install
Entertaining and Inexpensive

No. 2427—BUD POLICE THRILLER has a self-contained Regeneration Control. This model can be used on sets using screen grid or 27 for Detector Tube.

Price \$3.25

RELIABLE RADIO CO.

143 W. 45th Street, New York

They Work!

FILTER CONDENSERS

Here is a dry electrolytic self-healing condenser of 8 mfd. capacity which will give long, hum-free service in power supplies. The condenser is intended for use with an operating voltage of 400 volts, or slightly over, but will withstand a peak voltage of 600.

Type D Condenser, 49c

RELIABLE RADIO CO.

143 West 45th St. New York, N. Y.

"RADIO TROUBLE SHOOTING," E. R. Haan. 361 pages. 300 illustrations. \$3. RADIO WORLD, 145 W. 45th St., N. Y. City. New York City.

TEST OSCILLATOR



THIS Test Oscillator, Model 30-N, is serviceable for all intermediate frequencies from 135 k.c. up, and all broadcast frequencies, for lining up the receiver channels. It is constantly modulated and the same instrument works on 90-120 volts a.c. (any line frequency), line d.c. or batteries. Frequencies from 135 to 1,520 k.c. are direct-reading and never more than 1% off. Model 30-N is contained in shield cabinet. Etched metal scale is non-warping. Oscillator sent free (complete with 30-tube, ready to operate) on receipt of \$12 for a 2-year subscription for Radio World (104 issues, one each week). Order Cat. 30-N.

RADIO WORLD, 145 West 45th Street, New York, N. Y.

NEWLY DESIGNED 2 tube S. W. Kit Features Extreme Ease of Assembly

The simplicity of design and layout of this new Universal Mascot "2," plus easy point to point assembly and wiring instructions, make it possible for even a novice to build it.

In performance it is as efficient as most 3-tube sets due to the use of one 19 type dual Triode tube and a 32 screen grid tube in a regenerative resistance coupled audio amplifier combination. Every latest feature is incorporated in this remarkable set. For example, no longer is it necessary to reach behind the panel to change coils, for the Mascot "2" employs front panel plug-in coils usually found only in high priced sets.

Smooth regeneration control, complete shielding, band spreading, very low battery drain, loud speaker reception on foreign stations are other important features. The list price of \$17.50 is extremely low for a two-tube kit of this high quality. Dealers, Amateurs, Experimenters! Your discount is 40% off from your jobber or favorite Mail Order House . . . or net . . . \$10.50. If your requirements cannot be met, write us direct.

A WHOLE NEW COMPLETE LINE

The Mascot "2" is only one of the complete line of ICA Short Wave Kits, licensed under RCA and Hazeltine patents. The entire line comprises a one and two-tube battery operated set and three, four and five-tube A.C. operated sets. Get complete information concerning this amazing new line . . . the only one of its kind in America. FREE circular on request.



Insuline Corp. of America, Dept. F-66, 23-25 Park Pl., New York, N. Y.

SPECIAL

Set of 16 "1934 Design"

BLUE PRINTS

- Short Wave Receivers
- Short Wave Converter
- Tuners, P.A. Systems
- Broadcast Receivers

For Limited Time Only **50c**

Add 5c for postage. 10c for foreign

RELIABLE RADIO CO.
145 W. 45th St., New York City

A COMBINATION OFFER! RADIO WORLD and "RADIO NEWS"

\$7.00

Canadian and Foreign, \$1.50 extra.

You can obtain the two leading radio technical magazines that cater to experimenters, service men and students, the first national radio weekly and the leading monthly for one year each, at a saving of \$1.50. The regular mail subscription rate for Radio World for one year (52 weeks), RADIO WORLD, 145 West 45th Street, New York, N. Y. is \$6.00. Send in \$1.00 extra, get "Radio News" also for a year—a new issue each month for twelve months. Total 64 issues for \$7.00.

RADIO WORLD, 145 West 45th St., N. Y. C.

Quick-Action Classified Advertisements

7c a Word—\$1.00 Minimum

SELL NOVELTIES BY MAIL. Everything furnished. Catalogue, snappy sample, 10c. Braunn, 353 W. 47th, Chicago.

TELESCOPE—15c. Inexpensive, yet powerful. Focusing. Eight inches long. Also dime brings big bargain catalogue. Freund, 1639 Harford Ave., Baltimore, Md.

"SWOOP'S LESSONS IN PRACTICAL ELECTRICITY," 17th Edition, Revised by Erich Hausmann, E.E., Sc.D. Requires no previous technical knowledge; fully explains every question about the entire subject of electricity. New chapters on vacuum tubes, telegraphy, telephony and radio signalling. 709 pages, 542 illustrations, 5 1/2 x 8, Cloth, \$2.50. Radio World, 145 W. 45th St., New York, N. Y.

"THE RADIO HANDBOOK," including Television and Sound Motion Pictures. By James A. Moyer and John F. Wostrel, both of the Massachusetts Department of Education. For engineers, designers, operators, service men, experimenters. 386 pages, 650 illustrations, flexible. Price, \$5.00. RADIO WORLD, 143 West 45th St., New York City.

"RADIO TROUBLE SHOOTING," Second Edition, by E. R. Haan. Contains the latest on A.C. receivers, dynamic speakers and television. A practical book for practical men. Contains a special chart showing all possible radio troubles and the way to detect them. Size 6 x 9 inches. 361 pages, 300 illustrations. Flexible binding. Price \$3.00. RADIO WORLD, 145 W. 45th St., New York City.

TUBE SHIELDS FREE! Send \$1.50 for a 13-week subscription for Radio World and get, free, eight (8) tube shields suitable for the 57, 58 and other modern tubes. Subscription Dept., Radio World, 145 West 45th St., New York, N. Y.

Power Transformer for a BIG SET

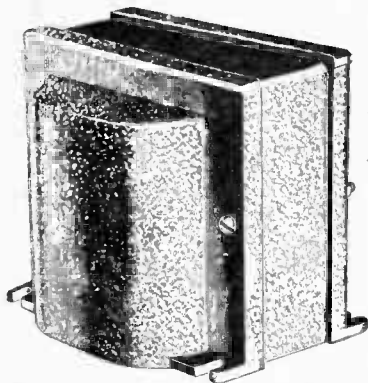

INSTEAD of using undersized, overheating, inefficient power transformers for a big set, why not use a cool-running, efficient transformer and pay the little extra? The Reliable transformer, Model 104-SP, will work an 18-tube set. Provides also the voltage for a 25Z5 rectifier.

- Primary = 115 v., 60 cycles
- Secondary X = 14 amp., 2 1/2 v., ct.
- Secondary Y = 6 amp., 2 1/2 v., ct.
- Secondary R = 5 v., ct.
- Secondary HV = 400-0-400 v., 200 ma.
- Secondary Z = 25 v., 0.6 ma.
- Lug terminals at bottom
- Price, \$3.95
- Shipping weight, 13 lbs.
- Immediate Delivery

RELIABLE RADIO CO.
145 W. 45th St., New York, N. Y.

ANDERSON'S AUTO SET

Designed by J. E. ANDERSON

FOREIGN RECEPTION ON 6-INCH AERIAL

This new auto set is the most sensitive set receiver we have ever come across. Mexican and Canadian stations were tuned in from New York City on a 6-inch aerial. The circuit, an 8-tube superheterodyne, with automatic volume control.

Complete set, which includes set chassis and set shield, battery box, remote control, battery cable, all condensers, resistors and coils, speaker with shielded cable; and a kit of RCA tubes (two 259 two 236, two 137, one 89, and one 85) are supplied less aerial.

Wired model, licensed by RCA, with complete equipment, less aerial, but including RCA tubes. Cat. 808-W \$37.40

RELIABLE RADIO CO.
143 West 45th St. N. Y. City

WAFER SOCKETS

6/32 mounting holes, 1-11/16 inches apart, central socket hole recommended, 1 1/4 inches although 1 1/8 inches may be used.

- UX, with insulator 10c
- UY, with insulator 10c
- Six-pin, with insulator 11c
- Seven-pin, with insulator 12c

HENNESSY RADIO PUBS. CORP.
145 WEST 45TH STREET, N. Y. CITY

Special Summer Trial Subscription Offer for NEW SUBSCRIBERS

Send \$1.00 in cash, check, P. O. money order, express money order or stamps, and receive

Radio World postpaid from now until Sept. 1.

Subscription Department, Radio World, 145 West 45th Street, New York City

ROLAND BURKE HENNESSY
Editor

HERMAN BERNARD
Managing Editor

RADIO WORLD

REG. U.S. PAT. OFF.
The First National Radio Weekly
THIRTEENTH YEAR

J. E. ANDERSON
Technical Editor

J. MURRAY BARRON
Advertising Manager

Vol. XXV

JUNE 16th, 1934

No. 14. Whole No. 638

Published Weekly by Hennessy Radio Publications Corporation, 145 West 45th Street, New York, N. Y.

Editorial and Executive Offices: 145 West 45th Street, New York

Telephone: BR-yant 9-0558

OFFICERS: Roland Burke
Hennessy, President and
Treasurer.
M. B. Hennessy, Vice-
President.
Herman Bernard, Secre-
tary.

Entered as second-class matter March, 1922, at the Post Office at New York, N. Y., under Act of March 3, 1879. Title registered in U. S. Patent Office. Printed in the United States of America. We do not assume any responsibility for unsolicited manuscripts, photographs, drawings, etc., although we are careful with them.

Price, 15c per Copy; \$6.00
per Year by mail. \$1.00 extra
per year in foreign countries.
Subscribers' change of ad-
dress becomes effective two
weeks after receipt of notice.

Types of Receivers Used for Bringing in Short Waves

By J. E. Anderson and Herman Bernard

[This is the sixth instalment of "The Short-Wave Authority." The seventh will be printed next week.—EDITOR.]

OF the two general types of receiver, the regenerative and the superheterodyne, which is the better all around? Which is chosen by those who are versed in the subject and who have had opportunities of comparing the two types? Does either have any points of superiority over the other?

Neither type has a corner on all the good points. The regenerative receiver has certain points of superiority for certain applications; the superheterodyne, likewise, has advantages which make this type preferable in other applications.

The regenerative receiver is simple and economical, yet it may be exceedingly sensitive if the regeneration control is properly designed. In this connection proper design means that the regeneration can be controlled smoothly so that the receiver may be operated very close to the oscillating point, just short of oscillation when voice and music constitute the signal and just after oscillation when keyed continuous wave signals are involved. Stability is an essential, for without it the regeneration adjustment could not be held at the point where the receiver is most sensitive. Perhaps the greatest advantage of the regenerative receiver is that it is quieter in operation than the superheterodyne. There is very little tube noise and hiss mixed with the signal brought in with a regenerative receiver.

The Super

The superheterodyne, as a rule, contains many tubes. This results in a high sensitivity. However, tube for tube, the sensitivity of a superheterodyne is not as great as that of a regenerative receiver. It follows that the tube noises are greater in the output of the superheterodyne than in that of the regenerative receiver. Indeed, hissing noise is one of the main drawbacks of the superheterodyne as it puts a practical limit on the sensitivity. If the sensitivity is increased beyond a certain point, the intensity of the signal is weaker than the extraneous noises.

There are many causes for the hiss. One is irregular emission of electrons from the cathode, which is known as the shot effect. Another is the irregular flow of current in conductors inside and outside the tube as a result of uneven thermal distribution. Still another is poor contacts at junctions of conductors, and to this type should be classed carbon resistors. We may also look to heterodyning of a multiplicity of different frequencies as a source of noise.

That heterodyning may be a prolific source of noise is borne out by the facts that the superheterodyne is noisier than the tuned radio frequency receiver, for the same sensitivity, that a superheterodyne in which there are two oscillators is noisier than one that has only one, that with every oscillation there is an infinite number of harmonics of various degrees of intensity, and that every detector tube, which means every tube in a receiver, generates all the harmonics of all the frequencies impressed on its grid. It is easily realized that in any superhetero-

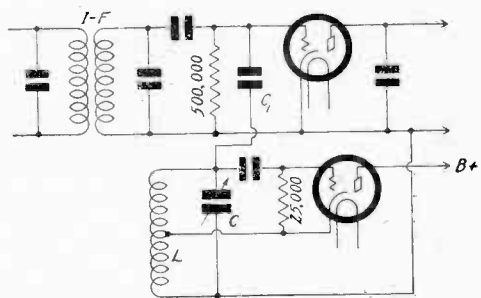

FIG. V-10

Continuous wave code signals can be received with a super-heterodyne if a beat oscillator is coupled to the second detector in this manner.

dyne there is an infinite number of frequencies that may beat together in an infinite number of ways. While the effect of the heterodyning of any two frequencies may be negligible, the combined effect of all of them may be a strong hiss.

The intensity of the hiss is particularly strong when a short-wave converter is operated with a broadcast superheterodyne. The receiver may be adjusted so that the hiss is just barely audible. Then the converter is started and its frequency control turned. The mere fact that the converter oscillator is going increases the hiss in the output of the receiver tremendously, but at certain settings of the converter oscillator the hiss is multiplied hundred-fold in intensity. At these points there is no modulated signal present, but only an unmodulated oscillation. When there is a modulated carrier present, the hiss increases, too, and unless the signal is very strong, it cannot be heard clearly through the noise. On a straight superheterodyne this signal could be heard without difficulty, and on a regenerative receiver without oscillation it could be heard distinctly.

Avoiding Hiss

Some of the hiss can be avoided by suitable design of the circuit. Since heterodyning and the production of frequencies for heterodyning increase with overloading of tubes in the receiver, care should be taken in the design of the circuit to avoid overloading. At no time during the signal cycles should a grid be allowed to become positive so that grid current will flow, and at no time should the grid potential be allowed to reach the plate current cut-off value. Strong signals make it difficult to meet these requirements simultaneously, for if the bias is made so high that there will be no grid current, it may be that the plate current will be cut off on the negative peaks of the signal. And if

(Continued on next page)

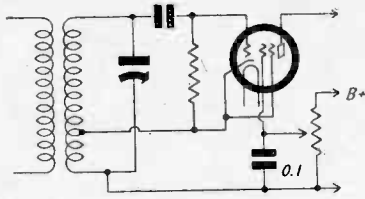

FIG. V-11

If the second detector of a superheterodyne is made regenerative both selectivity and sensitivity can be increased. This circuit illustrates a simple method.

(Continued from preceding page)

the bias be made so low that there will be no cut-off, there will undoubtedly be grid current. In such cases the applied plate voltage on the tube can be increased until the permissible swing of the signal on the grid is greater than the actual swing, assuming that the grid bias has the optimum value. If the plate voltage is already as high as the maximum recommended for the particular tube used, it may be necessary to change the tube to one having a lower amplification factor or to reduce the signal voltage impressed on the tube already in use.

Frequency Changer

The weakest link in the entire circuit, perhaps, is the frequency changer, that is, the first detector and the oscillator. The temptation is strong to make the voltage impressed on the detector by the oscillator as great as possible, because increasing the oscillation voltage increases the sensitivity. But if the sum of the signal and oscillator voltages as impressed on the detector exceeds a certain value, there will be strong overloading and this will give rise to hiss. Therefore it is of first importance to limit the input voltage to the first detector to voltages which the tube can handle.

The oscillator itself should receive consideration. The oscillation generated is not a pure wave, but a complex wave consisting of the required fundamental and all its harmonics. By correct design of the oscillator it is possible to make the total harmonic content exceedingly small, and that should be the goal when designing a quiet superheterodyne or short-wave converter. But it is infinitely more easy to design the oscillator so that the harmonics are by no means negligible in comparison with the fundamental. When they are relatively strong, we can expect a noisy receiver.

The coupling between the oscillator and the first detector is also important from the point of view of noise. It may be such that only the fundamental is impressed to any extent on the first detector, or it may be such the harmonics are impressed more strongly than the fundamental. We know that the current in the resonator of the oscillator is nearly free from harmonics. If, then, we can couple the grid of the detector to this we can impress the fundamental only. If this is done inductively, as it usually is, the harmonics will be intensified somewhat, but this is a small effect in view of the high purity of the resonant current. Yet it would be better to couple with a condenser for then the fundamental would be intensified and the harmonics would be suppressed. By condenser coupling is not meant that a small condenser should be connected between the grid of the detector and the high potential side of the oscillator, for this type of coupling emphasizes the harmonics. The simplest satisfactory way is to put a small coil on the resonator coil and to connect the small coil in series with the grid of the detector

Constant Frequency

Constancy of frequency is another consideration that must not be overlooked. If the frequency of the oscillator is not reasonably constant after it has been set on a particular value, it will fluctuate as a result of changes in the temperature of the cathode, in the plate potential, and in the signal voltage. Such

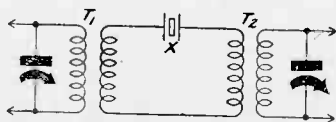

FIG. V-13

When extreme selectivity is required in a superheterodyne the signal may be forced to go through a crystal resonator, X, as in this circuit.

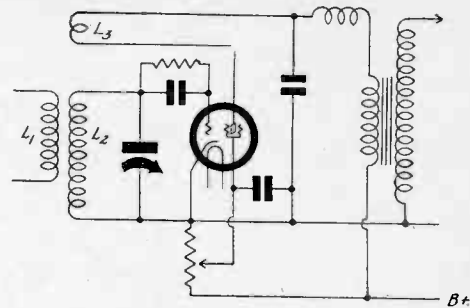

FIG. V-12

A conventional method of regenerating in a detector, which is applicable to a superheterodyne. The degree of regeneration can be set once for all.

variations in frequency will result in noise in the output. It may not be distinctly a hiss, but the noise that ordinarily is called hiss is made up of many different frequencies. If the frequency is held at a given frequency against the variations in temperature, plate potential, and the signal voltage, the hiss will be considerably less than if the frequency were allowed to vary.

If it were possible to reduce the noise in the output of a superheterodyne to the level it has in the regenerative receiver, the superheterodyne would undoubtedly be the choice in nearly all cases. But it appears that even with all precautions taken against the noise, there is enough left in the superheterodyne to make the regenerative receiver a strong competitor.

The Short-Wave Converter

When a sensitive radio receiver covering the broadcast band of frequencies is available, whether it be a superheterodyne or a tuned radio frequency set, it can be converted to a short-wave receiver by the addition of a short-wave converter. The essential feature of this device is a frequency changer, that is, an oscillator and a detector. The high frequency is changed by it to a lower frequency which can be tuned in with the broadcast receiver. If this receiver is a tuned radio frequency circuit, the addition of the frequency changer makes the combination a short-wave superheterodyne. If the receiver is already a superheterodyne, the addition of the frequency changer makes the combination a double superheterodyne, or a triple detector receiver.

While the essential feature of the converter is a frequency changer, it may have accessory features. For example, it may have a radio frequency tuner, or a radio frequency amplifier, or both. The tuner is particularly advantageous as a means of selecting the desired signal and suppressing interference, which it does by intensifying the desired signal. Another feature the converter may have is an intermediate frequency tuner, an intermediate frequency amplifier, or both. Improved sensitivity results from the use of an intermediate frequency amplifier and tuner, and it may also result in much improved selectivity.

It is the tuners, particularly, that improve the converter, but, unfortunately, they also make the converter more complex to build and more difficult to handle.

A Two-Tube Converter

In Fig. VI-1 we have a two-tube short-wave converter in which the frequency changer is preceded by a radio frequency tuner and followed by an intermediate tuner. The detector tube may be a 57 or one having similar characteristics, and the oscillator may be a 56 or similar tube. The detector is biased by means of a 10,000-ohm resistor in its cathode lead. The suppressor, which is ordinarily connected directly to the cathode, is in this instance connected to ground through a small pick-up coil. The suppressor voltage, therefore, is negative by the same amount as the control grid, yet the signal that may be impressed on the suppressor is greater than that which may be impressed on the control grid, and there is small chance that the detector will be overloaded by the oscillator.

The oscillator is of the Hartley type, which is characterized by a single coil with the cathode of the tube connected to a tap. The plate voltage in this case is the same as the screen voltage

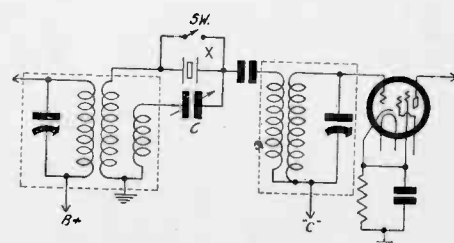

FIG. V-14

If the receiver is to be used for both code and telephone signals the circuit can be arranged in this manner, making the selectivity variable.

on the detector tube. The voltage may be as low as 22.5 volts, as far as oscillation is concerned, but may be over 100 volts. It is not at all critical and therefore whatever voltage is suitable for the screen will do for the oscillator.

The oscillator coil may be wound on a plug-in form, and since there are only four independent terminals, a four-prong form may be used. The tap on the oscillator coil should be near the center turn, with the larger winding on the grid side if there is any difference.

For the antenna coil a four-prong form might also be used. This will make it possible to put the antenna coil in the oscillator socket, and vice versa, but no harm will result. On the other hand, if a coil could be inserted in one of the tube sockets, damage might result. Since the oscillator takes a 5-contact socket and the detector a 6-contact socket, there is no danger of getting them mixed.

The Tuners

The tuned circuit LC1 is adjusted to the signal frequency to be received. Therefore the inductance of L1 depends largely on the value of C1. It is customary in short-wave tuners to use condensers of 140 mmfd. maximum capacity. For such condensers radio frequency coils are available in radio stores. Coils are also available for the oscillator if C2 is a 140 mmfd. condenser and the intermediate frequency is about 465 kc. These coils may be used even when the intermediate frequency is higher, as it will necessarily be if the converter is used with a broadcast set. The coil requirements are not at all critical if the two condensers C1 and C2 are separately adjustable. The only difficulty will be that the two dials do not track.

One of the most satisfactory arrangements for the tuner is to gang two equal condensers, each of 140 mmfd., using one in the radio frequency tuner and the other in the oscillator and then connect a separate condenser of about the same maximum value in shunt with C1. The main tuning is then done with the gang, for it controls the oscillator frequency; and the independent condenser across C1 is used only to increase the sensitivity.

The Beat Oscillator

When the radio signal consists of dots and dashes of continuous waves, the ordinary detector will not make it audible, at least not satisfactorily so. To make it easily readable it is necessary to introduce another wave the frequency of which differs from the frequency of the signal by an audible amount. When the receiver is of the superheterodyne type, this is best done in the intermediate frequency level. One way in which it may be done is shown in Fig. V-10, in which the upper tube is the second detector and the lower tube is the oscillator that generates the auxiliary frequency. The two circuits are coupled loosely together by means of a small condenser C, connected between the high potential side of the oscillator circuit and the grid of the second detector.

The tuned circuit LC is adjusted so that the frequency of oscillation differs by about 1,000 cycles per second from the intermediate frequency of the circuit I-F, because 1,000 cycles is near the frequency at which the human ear is most sensitive. The I-F tuner is adjusted in the usual way until all the circuits are adjusted to the same frequency. A continuous wave is then provided and the oscillator, by means of C, is adjusted until the beat note heard has the desired value.

After the adjustments have been made, neither the I-F nor the beat oscillator is tuned again, for all the necessary tuning is done by means of the high frequency oscillator. This is tuned until the beat note is heard most distinctly. There are two settings of the high frequency oscillator at which any given signal will come in, one where the intermediate frequency generated is 1,000 cycles higher than the beat oscillator and the other where the intermediate frequency is 1,000 cycles lower. Since the adjustment of the circuits can be made at only one setting, there will be a difference of intensity between the two, for if the adjustment was made when the signal was 1,000 cycles less than the beat oscillator frequency, the intermediate tuner will be 2,000 cycles out of tune when the signal is 1,000 cycles greater than the beat oscillator frequency. If the intermediate frequency tuner were no more selective than it is in a broadcast receiver, there would be no difference between the two, as judged by the ear, but when the tuner is as selective as it usually is for code, the difference in intensity may be very great. This is especially true when the tuner contains a quartz crystal.

This dual response is not the same as the ordinary image in a superheterodyne, but it is closely akin to it. It is an addition to that, for even when there is an auxiliary beat oscillator for bringing in code, the image interference is still possible. Just as it is necessary to have a high radio frequency selectivity in order to eliminate or suppress the image, so is it necessary to have a high intermediate frequency selectivity in order to suppress the second image.

It is interesting to note that when we have two oscillators it is possible to receive simultaneously four different signal frequencies. Two of these are reduced in strength by the radio frequency tuner and one of the remaining is reduced by the intermediate frequency tuner. Even if the four came through with approximately the same strength, the chance that they would be so nearly equal in audio frequency as to cause serious confusion is extremely small. But just the same, there is a good chance of getting much noise interference due to this

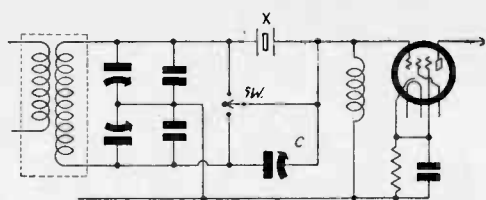

FIG. V-15

This illustrates another way of obtaining a variable selectivity. Either the crystal or the condenser can be shorted, or the switch may be set in the neutral position.

multiple response. A high selectivity is essential, first in the radio frequency tuner and then in the intermediate tuner.

Sharp I-F Tuners

There are two comparatively simple ways of getting a high selectivity in the intermediate frequency level. One is the use of regeneration and the other is the use of quartz crystal resonators. Of course, there are many variations in these two general methods.

A very simple regenerative circuit is shown in Fig. V-11, which is based on the Hartley oscillator. The regeneration is controlled by means of a potentiometer in the screen circuit, so connected that by moving the slider the effective screen voltage can be varied. The more nearly the circuit is to the oscillation point, without actually being in a state of oscillation, the more selective, as well as more sensitive, is the circuit.

Another and more common regenerative circuit is shown in Fig. V-12. It represents the second detector of a superheterodyne, together with the last intermediate frequency circuit. There are three windings on the transformer, namely, the primary which is in the plate circuit of the preceding tube, the secondary which is in the grid circuit of the detector, and the tickler, L3, in the plate circuit of the detector. Regeneration is controlled by means of a potentiometer in the screen circuit of the tube. Since the frequency involved is always the same it is possible to make the regeneration adjustment once and then leave it. This adjustment could also be done by moving the tickler coil in respect to the tuned winding.

Sensitivity Improved

Regeneration in the intermediate frequency amplifier not only increases the selectivity but it also greatly increases the sensitivity. It would seem that its use would be advantageous in all receivers, but this is not the case. The reason is that the selectivity is likely to become too great for good quality. This is particularly the case when the intermediate frequency is low, 45 kc, for example. A little regeneration at this frequency makes the signals low in pitch and noticeably removes the higher frequency elements of the signal. The effect is not so great when the intermediate frequency is higher, but it is there, and it is only a matter of degree of regeneration. Even if the intermediate frequency is of the same order of magnitude as the radio frequency carrier, excessive selectivity results if the regeneration is advanced too far. It does not help to use band pass filters for the regeneration will not cover a band but will be concentrated on one frequency. For code reception the high selectivity is desirable.

The other way of getting a high selectivity is to use a quartz crystal filter. Several arrangements have been devised for taking advantage of the high selectivity of a crystal. One of the simplest ways is illustrated in Fig. V-13, in which there are two ordinary tuned circuits and one crystal. The crystal, X, is in series with the link connecting the two tuned circuits. Compared with the crystal, the two coil-condenser circuits are very broad and they really do not contribute a great deal to the selectivity, but they do aid in increasing the sensitivity.

Signal Path

The signal is delivered to the link circuit by the first tuned circuit, and the link in turn delivers it to the second tuned circuit. But the crystal acts as a narrow slit through which only one wavelength can pass. If it is tuned to 450 kc, say, it will pass this frequency with practically no attenuation, but will suppress a frequency only about 2,000 cycles removed from 450 kc to about one-half of one per cent. The frequency from the auxiliary beat oscillator will not be suppressed although it will differ by about 1,000 cycles from the natural frequency of the crystal, because the beat frequency oscillation is introduced after the sharp filter. Therefore the sharp selectivity is not accompanied by a reduction in the sensitivity.

A coupler in which the principle illustrated in Fig. V-13 is applied is shown in Fig. V-14. In addition to the crystal circuit, however, there is another in which there is a variable condenser, C, in place of the crystal. Also, there is a switch by which the crystal can be short-circuited. With the crystal
(Continued on next page)

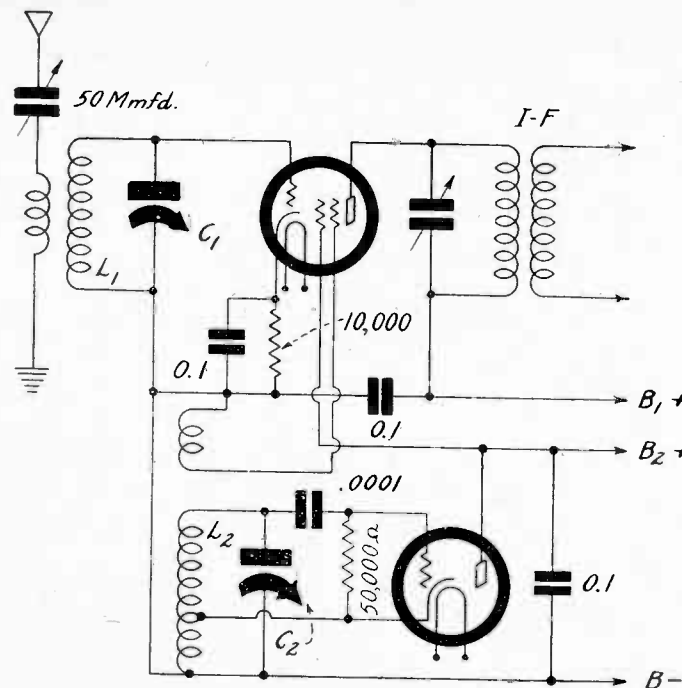

FIG. VI-1

A short-wave converter with one r-f tuner, one i-f tuner, and oscillator.

(Continued from preceding page)

shorted the signal does not have to go through it to get to the next tuner and therefore the selectivity is comparatively low. It is right for the reception of broadcast programs.

The variable condenser in the circuit shunting the crystal is called an elimination control and its function is to vary the selectivity gradually from full crystal sharpness to the comparative broadness of the coil-condenser circuit. The switch across the crystal is open when the variable condenser is employed for this purpose. Sharp selectivity is sometimes needed to receive telephone signals where full crystal selectivity would be excessive and the broad tuning suitable for broadcast program reception would be insufficiently sharp. In such cases the variable feature is desirable.

A different way of accomplishing the same result is given in Fig. V-15. In this case either the crystal or the condenser can be shorted with the switch, or the switch may be set in neutral position where the crystal can be made more or less effective by adjusting the capacity of the condenser C.

When the full sensitivity of the crystal resonator is used, which it may be when continuous wave code is being received, the tuning control must be micrometric. The need for this becomes obvious when we consider the selectivity of the crystal, which may be hundreds of times greater than that of the coil-condenser tuner. To get the maximum response we must exactly on the resonance peak. If we are off, say, 50 cycles, the signal is nearly tuned out. It is the high frequency oscillator that must be adjusted with extreme care when the circuit is super-selective.

The short-wave converter can be simplified a great deal by using one of the multi-electrode tubes both for oscillation and detection. There are four different tubes of this kind which have been designed especially for this service. They are the three pentagrid converters, 1A6, 2A7, and 6A7, and the triode-pentode 6F7. Of these the 6F7 is probably the most suitable, although it requires a slightly more complex circuit than any one of the other three.

Fig. VI-2 shows a converter circuit built around the 1A6, a 2-volt, 60-milliampere pentagrid designed for all battery operation. In this circuit as in Fig. VI-1 there are three tuned circuits, L2C2 for the high signal frequency, L4C4, for the oscillator, which is tuned to a still higher frequency, and the primary circuit of the intermediate transformer T, which is tuned to the difference between the signal and oscillator frequencies.

The oscillator is of the tuned grid type, the first grid being used as control grid and the second as the anode for the oscillator. A stopping condenser, C5, blocks the grid and a grid leak, R2, is connected between the control grid and the negative terminal of the filament. C5 may be about 500 mmfd. and R2, 50,000 ohms.

The detector is of the grid leak type, the cap grid being used for control grid. A stopping condenser, C3, of 100 mmfd., is connected in the lead to the cap and it is shunted by a resistance, R1, of 2 megohms. The grid leak is connected so that the return is made to the positive end of the filament and to ground.

C1 is a small trimmer condenser in the antenna circuit and should have a maximum value of about 50 mmfd. The two tuning condensers C2 and C4 should be 140 mmfd. units. The I-F tuner should be as nearly like the tuners in the radio frequency

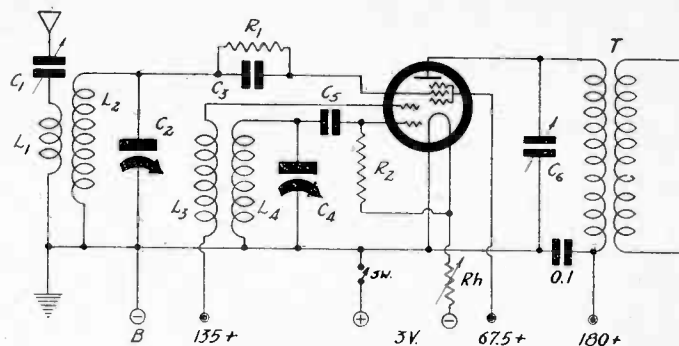

FIG. VI-2

The circuit of a battery operated short-wave converter employing tuned radio frequency input and tuned intermediate frequency output.

receiver with which the converter is used as possible, for then the dial of C6 will track with the tuning dial on the receiver. Of course, since C6 can be turned independently of the receiver control, it is not essential that the I-F tuner be exactly like the tuners in the receiver, but it should cover about the same tuning range. Thus C6 should be a condenser of the same capacity rating as the condensers in receiver, and the primary of transformer T should have the same inductance as the inductance in each tuned circuit in the radio frequency amplifier.

As far as operation of the converter is concerned, any one intermediate frequency could be selected and the output circuit of the converter tuned to that. It would then not be necessary to have an accessible control for C6, for it could be adjusted once for all. But this restriction on the intermediate frequency is not always desirable, for there may be interference on the frequency selected. If, then, the tuned output circuit of the converter were not adjustable it would not be possible to select some intermediate frequency on which there were no interference. Freedom of choice of any intermediate frequency within the tuning range of the broadcast receiver is very desirable, even if this necessitates the omission of the tuned output circuit of the converter and using untuned coupling between it and the broadcast set.

Supply voltages for the 1A6 are indicated on the circuit diagram, Fig. VI-2. Since the tube requires a filament voltage of two volts and the supply is three volts, a rheostat, Rh, of 20 ohms should be put in the negative lead of the circuit. The filament switch (Sw), which is shown in the positive lead, may be combined with the rheostat.

A-C Converters

An A.C. operated short-wave converter, employing either a pentagrid or triode-pentode, is shown in Fig. VI-3. If the heater supply voltage is 2.5 volts A.C., the tube should be a 2A7, and if the supply voltage is 6.3 volts, the tube should be either a 6A7 or a 6F7.

This circuit has been simplified a little as compared with the circuits in Figs. VI-1 and VI-2 in that the antenna is connected directly to the tuned circuit through the small antenna trimmer condenser and that the output circuit is not tuned. This circuit is more easily tuned than either of the preceding, mainly because of the omission of the output intermediate tuner; but it will not be as selective or as sensitive as either of those circuits. Best results will be obtained with this untuned output coupler when the impedance of the input circuit of the broadcast set is high, that is, when it is as high as or higher than the output impedance of the pentode section of the tube. The terminals marked A and G should be connected, respectively, to the antenna and ground posts on the broadcast receiver.

The simplified input circuit has one advantage over a circuit in which the antenna is coupled loosely to the tuned circuit without a chance for varying the coupling. Suppose the condenser C0 is set at maximum when a station not previously received is to be tuned in. The circuit L1C1 is then very broad and has very little effect on the tuning. The station can be tuned in with the oscillator alone. Once received, the coupling can be loosened by setting C0 at a lower value and the tuned circuit L1C1 can be adjusted to resonance with the desired station. Greatly increased selectivity and sensitivity result.

The output choke Ch is to function at frequencies in the broadcast band. Hence a coil of about 10 millihenries will do. The stopping condenser may have any convenient value, say 0.001 mfd. Instead of using an untuned choke, a parallel tuned circuit could be used just as well, but in that case the impedance across the AG terminals should be at least 100,000 ohms and preferably a pure resistance. Putting in a parallel tuned circuit, of course, requires an added control.

The other values of resistances, condensers, and inductance should be the same as the corresponding parts in the preceding circuits.

If the supply voltage is 6.3 the tubes should be either a 6A7 or a 6F7. But the 6F7 requires external coupling between the

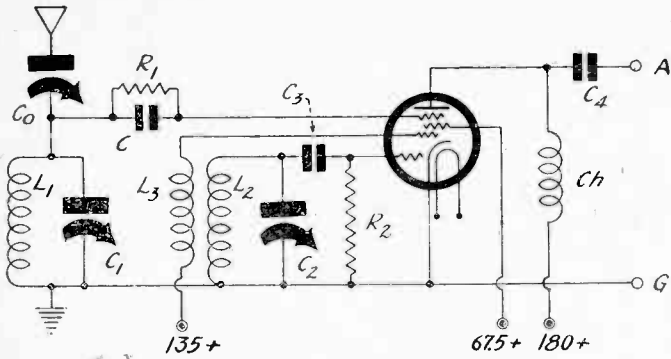

FIG. VI-3

An a-c operated short-wave converter with tuned input and choke output. A pentagrid converter tube or a triode-pentode may be used.

pentode and the oscillator, for the elements are not so placed internally as to provide the coupling. Therefore there should be a small pick-up coil connected in series with the cathode and wound on the form for L2. The number of turns on this pick-up depends on the inductance of the tuning coil. The adjustment of the turns of the pick-up winding and of the coupling should be done experimentally for best results.

There is no provision for heater and plate power supply in the two A.C. operated circuits. Batteries could be used, but they are hardly practical. Sometimes it is feasible to take the filament current and the plate voltage from the receiver with which the

converter is to work. When this is not convenient, the simplest way is to build up a small power supply.

Fig. VI-4 shows the circuit of a universal converter, that is, a converter which may be operated on either A.C. or D.C. power lines. It contains a 25Z5 rectifier and a hum filter, which consists of one choke, Ch, of 30 henries or more, and two 8 mfd. electrolytic condensers. The tuner in this converter is essentially the same as that in Fig. VI-2, but the pentode operates as a grid bias detector and the output intermediate tuner is of the tuned impedance type.

The heaters of the 6F7 and the 25Z5 are connected in series. Since the rectifier requires a voltage of 25 volts and the converter tube a voltage of 6.3 volts, the total voltage in the heater is 31.3 volts. The line voltage will, in general, be 115 volts. Hence there is an excess of 73.7 volts. To drop this a resistor R4 is connected in the positive lead. The current through the heater circuit is 0.3 ampere and therefore the resistance should be 246 ohms (a commercial 250-ohm resistor). The wattage rating should be 25 watts or more.

The control grid for the detector is biased by means of a resistor (R1), of 1,000 ohms. The oscillator control grid is biased by means of a 50,000-ohm resistor connected between the grid and the cathode. This resistor might be increased to 100,000 ohms provided blocking does not occur at that value.

The pick-up coil, which is required when the triode-pentode tube is used, is connected in the cathode lead between the grid bias resistor and ground. By putting the pick-up coil in this position the terminal arrangement on the coil is simplified, since only one of the terminals need be switched when changing coils. In case plug-in coils are used a five-prong form can be used, and if switches are used, only four decks are required for the oscillator coil and two additional decks for the antenna coil. If the plug-in system is used the antenna coil requires a four-prong form.

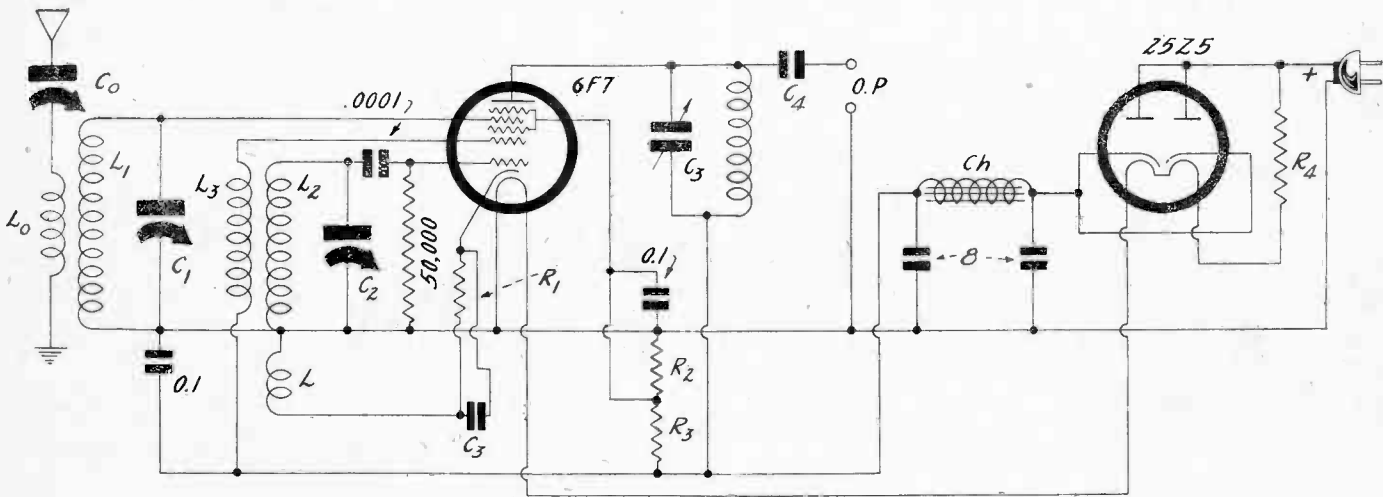
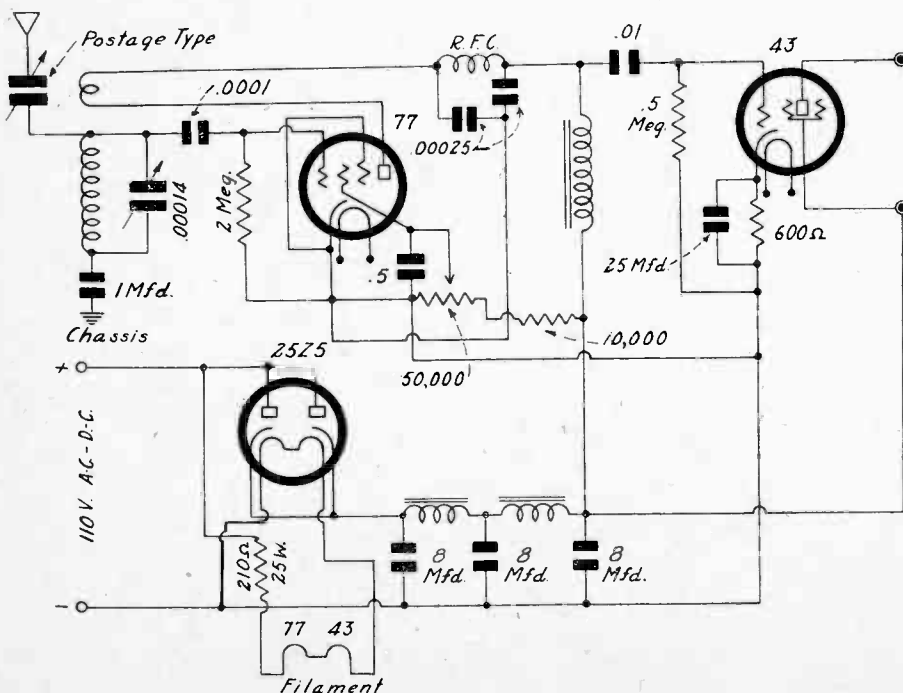

FIG. VI-4

A universal short-wave converter in which the oscillator-detector is a triode-pentode and a 25Z5 is used for power supply rectifier.



It is well to complete the filtration after the detector by including the condenser to right of RFC. The value should not exceed 0.00025 mfd. for a transformer primary or choke, and 0.0001 mfd. for a resistance load.

Finding Frequencies

In a Small Short-Wave Set

By Jack Tully

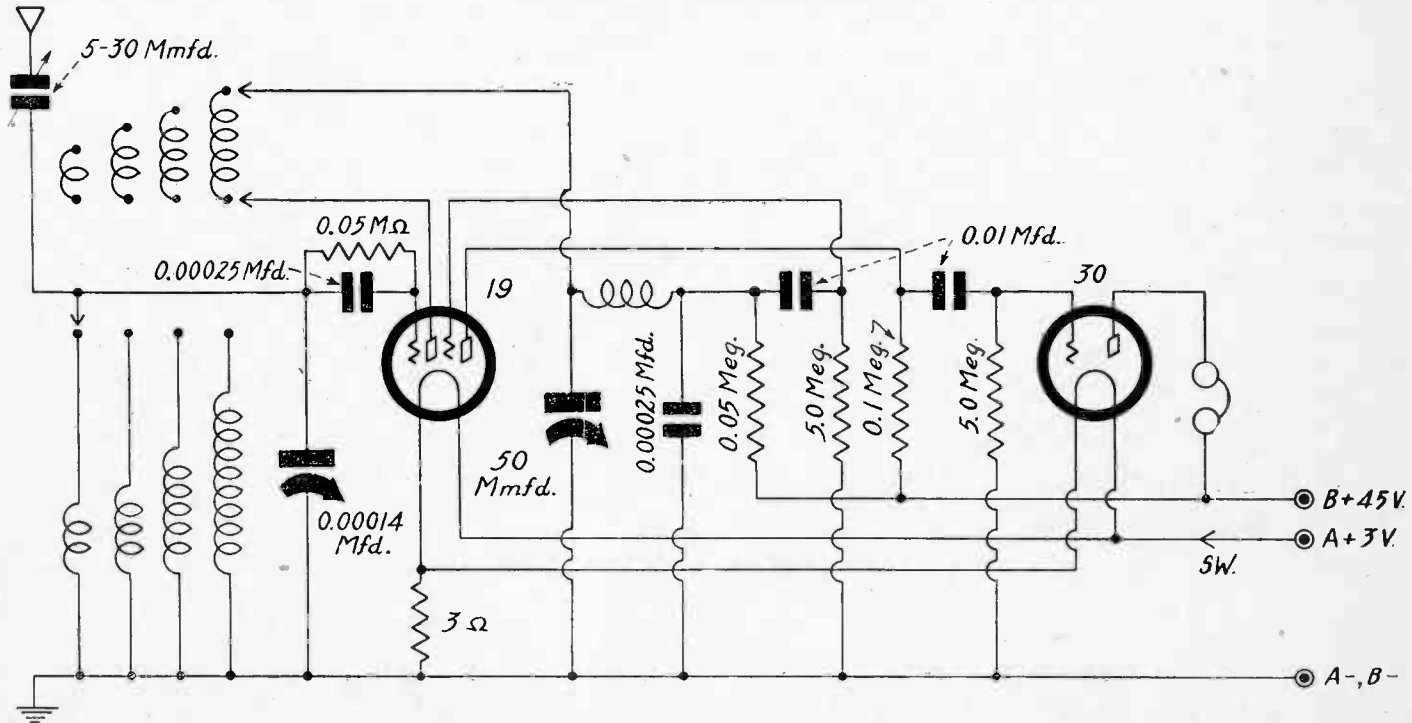

Circuit of a switch-type short-wave battery-operated receiver, using the 19-tube as a detector and first audio amplifier, and a 30 tube as the output to a pair of earphones.

THERE are beginning to appear some kit-circuits of the two-tube type, using switch-coil systems, instead of plug-ins, and while the calibration of the receiver is not yet included, it may be, either directly or indirectly, in the near future.

The accompanying diagram shows the new 19 tube used as regenerative detector and first audio amplifier, followed by a 30 output tube, thus yielding three-tube performance, for earphone use. A discussion of this circuit was printed last week, issue of June 9th.

A Phase Shift

The wiring is very simple, the result is a compact set, and the regeneration control is excellent. The coils are to be wound by the constructor experimentally, the data for the lowest-frequency coil having been given last week.

The fact should be added that for coils to cover higher frequencies, besides secondaries selected for proper inductance, ticklers likewise must be put on for proper inductance and coupling, so that when the condenser plates are totally enmeshed, in the feedback circuit, there will be oscillation at the lowest frequency receivable with the existing combination of secondary inductance and capacity across it.

Calibration

It will be found, however, that for the smallest coil, the regeneration condenser setting, for most of the frequency spectrum covered, has to be just the opposite to that for the lower frequency bands. This is no doubt due to the phase shift arising in the tuned circuit on account of the low capacity reactance.

If such a circuit as this is to be frequency-calibrated, which may be done with the aid of the frequency-dial setting charts being printed weekly in these columns, then one may calibrate for the regenerative condition, and the calibration will hold fairly well, or may calibrate for a particular oscillatory condition, for instance, with feedback condenser plates totally enmeshed, to pick up carriers by the squeal method, and then, having located them, retard the regeneration control until the set is just below the oscillating condition, when the tube is most sensitive for reception. The actual setting will have to be shifted just a trifle from what was established at first, due to the detuning by reduction of the feedback capacity

when one changes the circuit from an oscillator to a regenerator.

The foregoing assumes that the series antenna condenser is of a particular value, say, 25 mmfd. If so, it is selected on the basis of permitting regeneration all over the dial for the smallest coil, and left thus. The sensitivity is reduced at the lower frequencies, on account of the fixed series antenna condenser, but the selectivity is increased about proportionately. In the light of this circumstance the two-stage audio channel was included, even for earphone use, so that at all times and under all conditions where reception is possible, there will be sufficient volume.

If the series condenser is adjustable, another factor is introduced that changes

The 6-volt tubes are growing in popularity, for auto use of course, with or without vibrator shown at right. When a motor generator or vibrator is used, of course, the tubes are a-c operated.

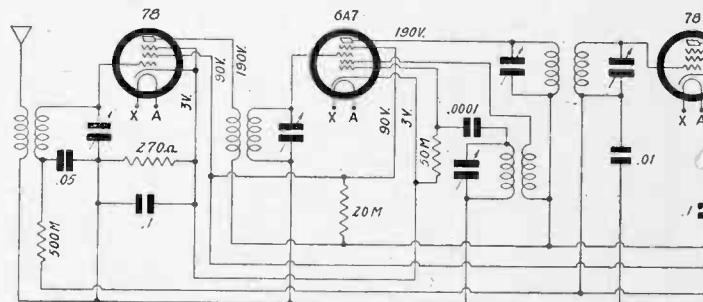

Capacitors C₁ & C₂ are of the high temperature type

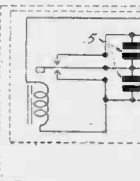

A Signal Generator

Using the 34 and a Small Neon Tube

By Gaston Franc

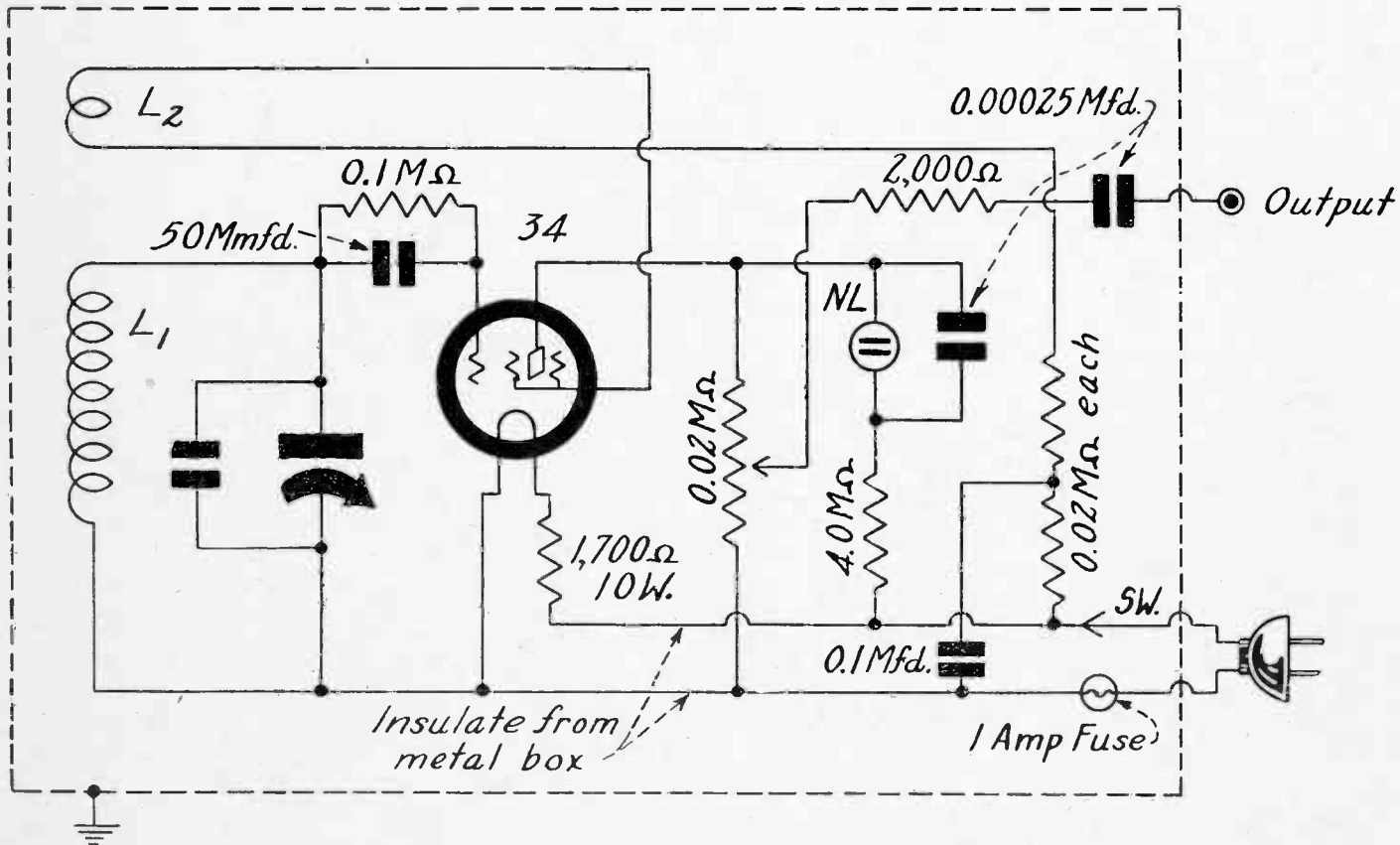

The model 34-AB signal generator.

the calibration, and this is on such a serious one that no calibration can be considered of high value in such a circuit if the setting of the series antenna condenser is not made a part of the calibration, and the same aerial used as when the calibration was made.

Another method is to put a small oscillator in the set, 1,600 to 3,200 kc, and weakly couple it to the detector. If this oscillator is calibrated, since the approxi-

mate ranges of the coil-condenser systems in the set will be known, the harmonic order of the test oscillator or frequency of the set, will be known when the calibrated oscillator is used for measuring. An excellent way to build such an oscillator is to use a high-capacity tuning condenser, preferably of the straight capacity line type, say, 0.0005 mfd., and put across it enough fixed capacity so that the capacity ratio is 4.1.

HEREWITH are the diagram and the constants for the Model 34-AB Signal Generator, which works on a.c., d.c. or batteries, 90-120 volts. If the source is a.c. it may be of any frequency. Modulation always is present. On a.c. it is the hum frequency. On d.c. it is the note of the neon tube used as audio oscillator. This tube is only as long as your finger-nail. It has no series resistor built in. The neon tube also oscillates thus on a.c., but the modulation due to this tube is drowned out by the hum. Only at resonance does anything come through.

The 34 tube is used really as a triode, and the formal plate is used simply as an electron pickup device. Thus there is practically no change in frequency, no matter what the setting of the attenuator.

There is some blocking of the line, also provision for uniform selectivity at all settings. A measure of frequency stabilization is introduced, also, due to the limiting resistors in the screen circuit. The screen is the feedback element.

If there is no trimmer across the tuning condenser, the high-frequency setting may be made by adjusting a grid condenser. Tune in a station at 760 kc or lower, but close thereto, and beat the second harmonic of the signal generator with the station fundamental. Thus for 760 kc the frequency setting would be 380 kc. This is on the frequency-calibrated etched-metal scale, with the other frequencies, 132 to 380 and 528 to 1,520 kc.

Short waves can be calibrated, too.

If the 6-volt tubes are used in the regular way for a-c tubes, line-current operated, there is a power economy, since the heater normally takes 2 watts, compared to 2½-volt tubes' 2½ watts or more.

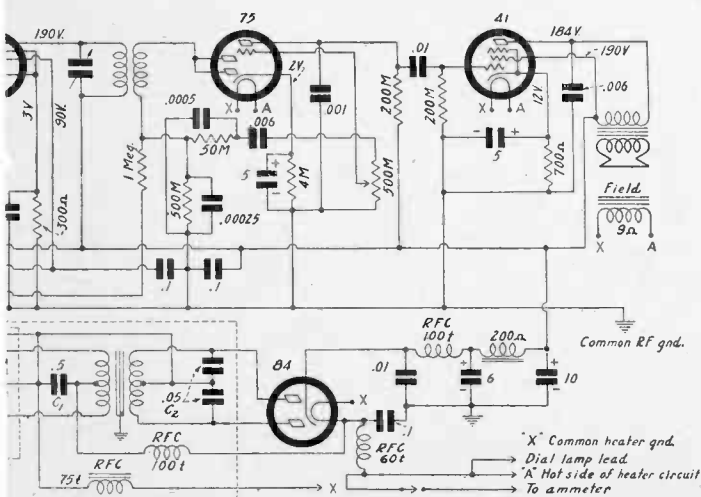

2,650 to 5,400 Kc Chart for Bud 0.00014 Mfd. and Yellow-Ringed Alden Plug-in Coil

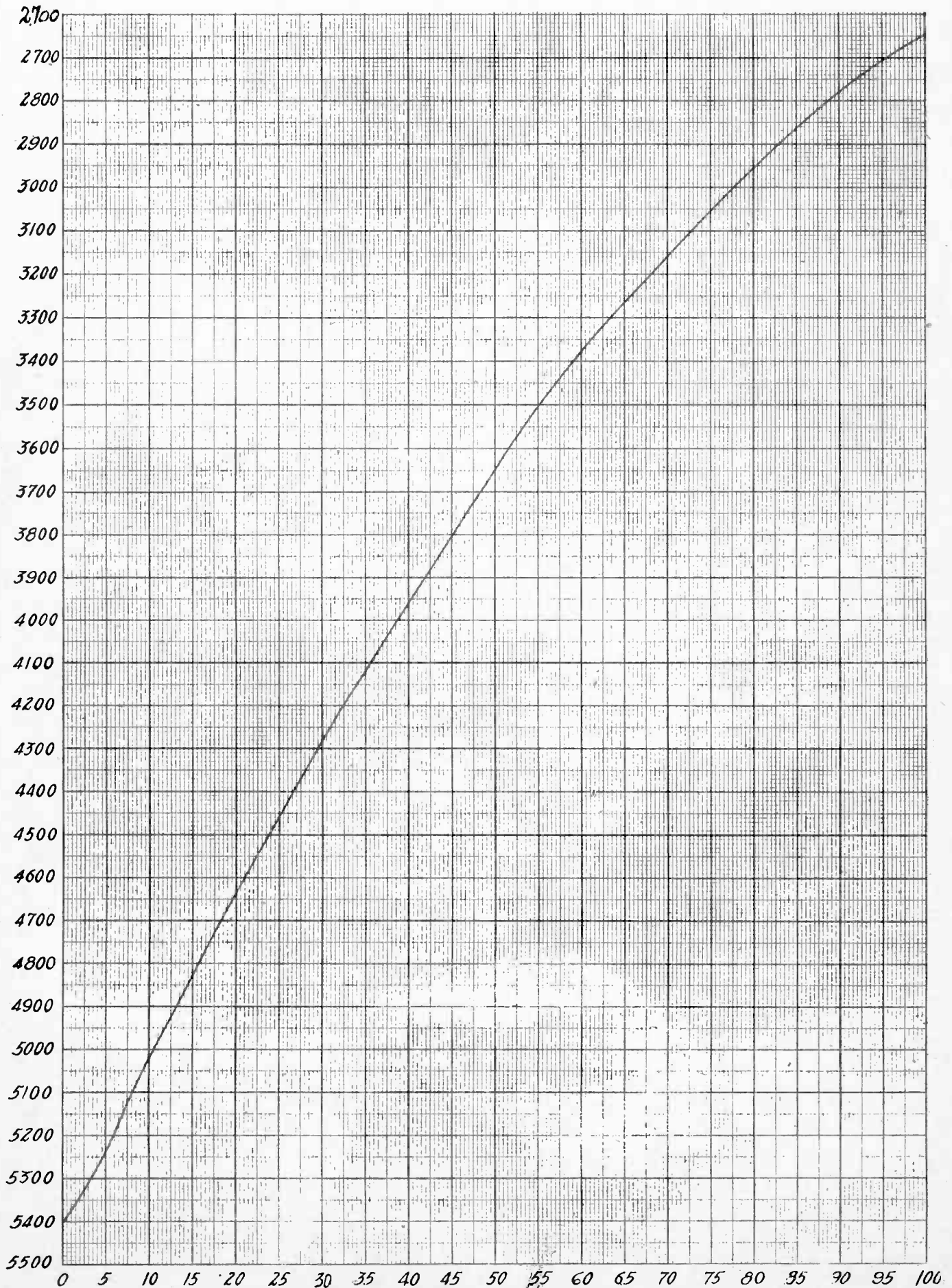

5,250 to 14,000 Kc Chart for Bud 0.00014 Mfd. and Red-Ringed Alden Plug-in Coil

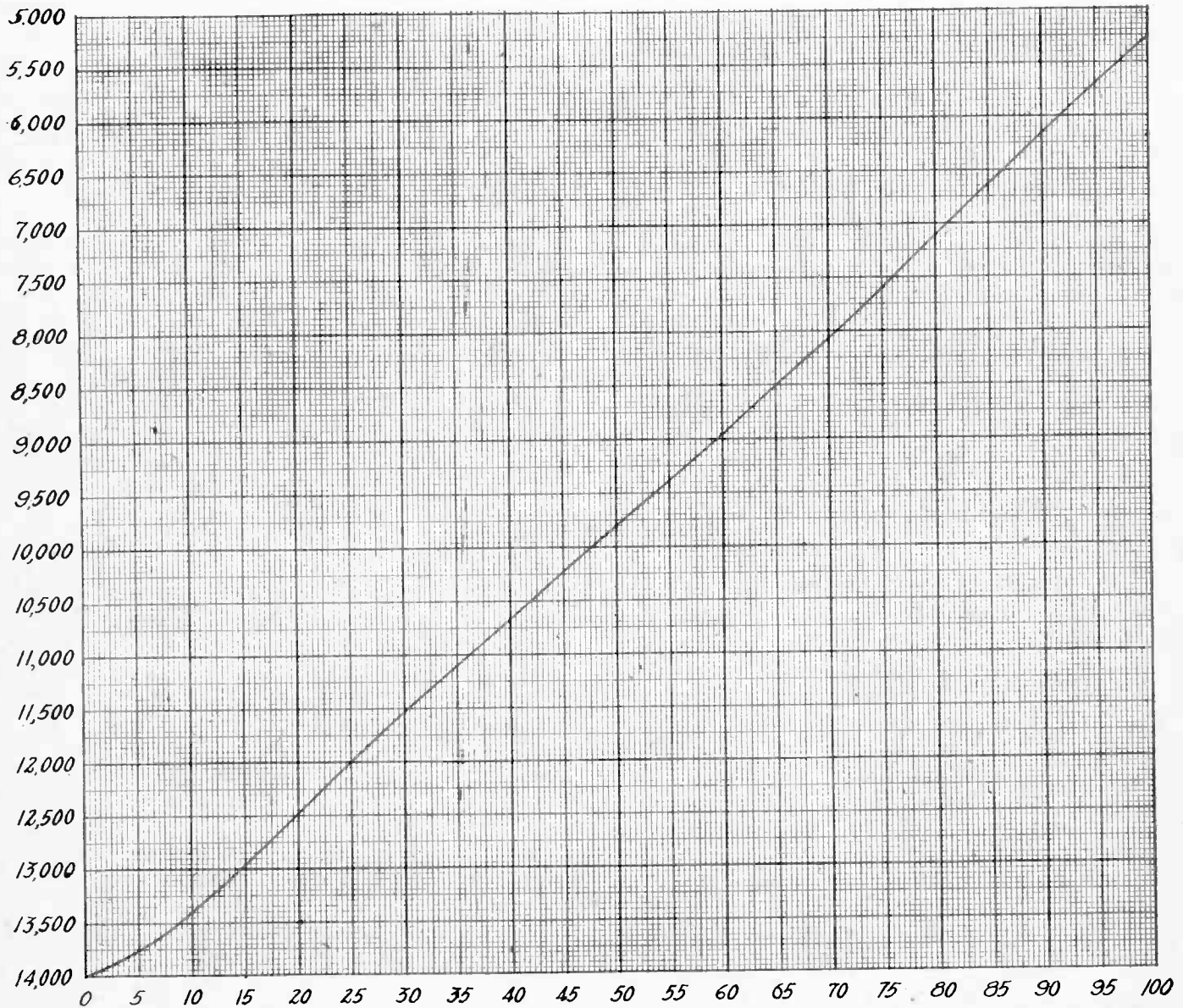

(Continued from page 2)

the frequencies stay put. Even if mica-dielectric condensers are used for trimming, the usual compression type, the accuracy remains high. But the moment one gets into short waves, if there is to be any parallel capacity of a fixed and intentional nature, as for permanent trimming, air-dielectric condensers of good quality should be used.

Two Purposes

The small differences in capacity resulting from moisture, temperature, mechanical displacement and the like cause quite an upset in frequency and render calibration insecure, even if moulded mica fixed condensers are used, as the commercial types have a fixed space inside, nearly always with enough room to permit expansion and contraction of the plates and shifting of the dielectric.

In short-wave sets of the battery-operated type, consisting of one, two or three tubes, it is not usual to have any trimming capacity, hence this particular problem then does not arise.

What the Squeal Reveals

There are two principal purposes to which the series of curves for combinations of commercial coils and condensers may be put. One is that the very components may be put into the identical circuit used (as shown in the June 2d issue) and the curves takes as representing the resultant frequencies, and the other is that an oscillator may be built, according to a diagram in the same issue, and that oscillator used as a station-finder. It may be used on fundamentals only, by resorting to plug-in coils, or on harmonics, by using only the first or largest—inductance coil.

Then by loosely coupling to the antenna a squeal will be heard every time a carrier is tuned in, and as one has an approximate idea of the frequency region, as supplied by the coil maker, the actual frequency may be ascertained by multiplying the station-finder fundamental by 2, 3, 4 or possibly, in some instances, 5. Which factor to use for multiplication is easily determined by the general knowledge of the frequency region. For a four-coil system, roughly, the frequencies are 1,600 to 3,500, 3,000 to 7,000, 6,000 to 13,000 and 12,000 to 25,000 kc, using 0.00014 mfd. and standard plug-in coils.

Finding a Frequency

Suppose then one is working a set with the second coil, 3,000 to 7,000 kc, and reads the station finder at 1,720 kc. What is the actual frequency to which the receiver is responding? Well, 1,720 kc is near the low-frequency end of the tuning of the station-finder, and as 1,720 goes into 3,000 nearly 2 times, the second harmonic is being used, and the frequency is 3,440 kc. The third harmonic would be 5,160 kc, which would be near the high-frequency end of the tuning of the set, hence is ruled out.

When the receiver frequencies are high, even though no harmonic greater than the fourth is used, there is some cause for confusion, but since then the number of responses yielded by the station-finder may be counted for its entire dial span, experience will teach you to correlate the number of responses to the frequency, hence for numerous responses, look for a higher frequency, and preferably use the highest fundamental frequency of the station-finder to ascertain what the receiver frequency is.

10,000 to 23,000 Kc Chart for Bud 0.00014 Mfd. and Blue-Ringed Alden Plug-in Coil

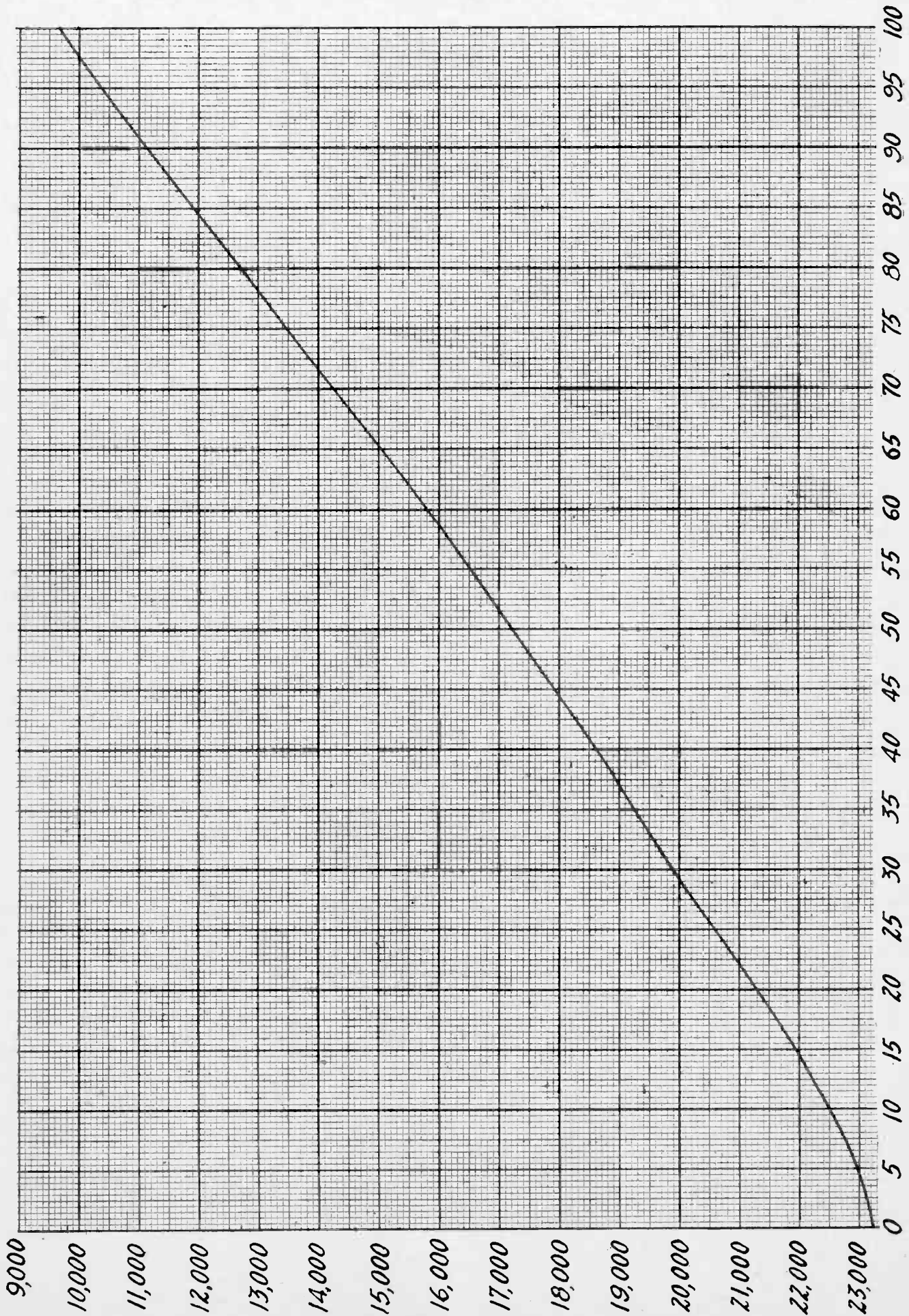

Radio University

Short Antenna

IS IT TRUE that a short antenna is better than a long one for short waves? —J. C. S.

Yes, this is generally true, especially as short antennas are more efficient at short waves than long ones, are used by transmitters, and receiving antennas

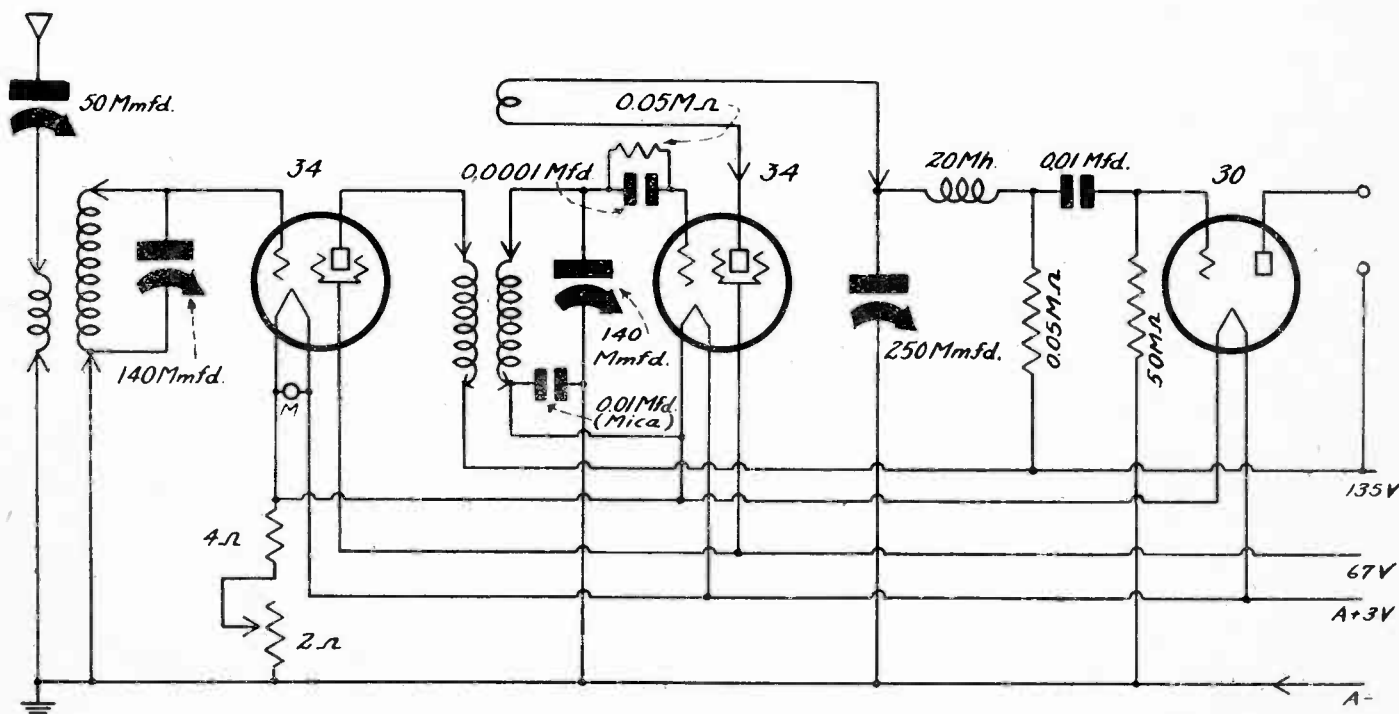

A switch type short-wave battery-operated receiver in which the unused coils or windings are totally disengaged.

T. R. F. on Short Waves

WHICH IS PREFERABLE, to have a regenerative detector for short waves, and two stages of audio, or to have a t-r-f stage, a regenerative detector and one stage of audio? I have in mind a battery-operated set, with switching.—L. O.

In general, the regenerative detector and two stages of audio would be preferable, because of simplicity of problems, hence better results as obtained in general construction. If one is well acquainted with the science of short-wave radio, he will fare better perhaps with a t-r-f stage and a regenerative detector, but to get this circuit working properly, special precautions must be taken. There must be no feedback from one stage to the other, hence coupling must be confined to the tube loads. Semi-shielding is often resorted to, but close shielding is usually taboo, as the losses arising may be greater than the gain the r-f stage is intended to produce. If the shield is very large compared to the coil diameter, and comes no nearer than say 1.5 to 2 inches of the coil at any place, the shield may completely surround the coil. However, shield partitions are often selected as being quite suitable. For switching, as shown in the diagram, some recommend that the coils be totally released from the operating circuit and even the d-c potentials. Some manufacturers short out unused windings, for then there is no voltage across the unused coils although if care isn't taken losses may then be severe nevertheless, because of enormous current through the short. This point must be watched with extreme care.

Accuracy of Calibration

ARE COMMERCIAL receivers accu-

rately calibrated in frequencies, when they have frequency-calibrated dials for short waves, and if not, why not?—L.M.

There are no accurately-calibrated commercial short-wave receivers so far as we know, and the closest to accuracy are the charts supplied by some manufacturers of communication type receivers. However, even a chart can not be accurately read, unless it is measured in feet, rather than in inches. For the usual chart 3 per cent. accuracy of reading is good. If the dial is frequency-calibrated the accuracy can be made around 1 per cent., or even better, but precision type of construction, not found in commercial receivers, is necessary, including frequency-stabilization (freedom from drift and wobble), correction for changes in temperature, and some regard also for the effect of moisture and temperature on inductances and on mechanical devices.

Harmonic Accuracy

WHEN ONE USES a low-frequency oscillator for measuring high frequencies, by harmonics, if the low-frequency oscillator is accurate to 1 per cent., how accurate is the fifth harmonic, for instance? Is it 5 per cent.? Please let me know just how to figure this out.—K.C.

No. The percentage accuracy does not change, but the absolute frequency difference does. Suppose the low-frequency oscillator generators 1,000 kc. Suppose the accuracy is 1 per cent. The reading on the scale will not be off more than 10 kc. Suppose the fifth harmonic is used. That is 5,000 kc. The accuracy is still 1 per cent. But 1 per cent. of 5,000 kc is 50 kc, or the absolute variation is five times as great as in the first instance.

should, in general, be electrically the counterparts of the transmitting antennas, as far as practical. It is also true that there is in general more pickup from longer antennas, because of greater capacity and inductance, but the set itself then works less efficiently. One may consider the efficiency as the output compared to the input. If much is put in, including a lot of interference, much will come out, including the interference. If less is put in, the resistance introduced into the set by the aerial is lowered, the receiver efficiency is greatly improved, and the output is much more useful or enjoyable. When very long antennas are needed for adequate volume of reception on short waves it is time to question the value of the receiver.

Crystal Filter

WHAT IS the use of a crystal filter in a short-wave superheterodyne for program reception?—H. D. C.

No use. Such filters sometimes pass band widths of only 50 cycles at the intermediate frequency, therefore cut off all program reception. They are useful for code reception, however, to get rid of interference, which they wipe out completely.

Position of Tubes

MAY TUBES be used in any position, or must they always be upright, that is, base pins at bottom at right angles to chassis top?—K. D. C.

The filament type tubes should be used upright. The heater type tubes may be used in a horizontal or upright position. If horizontal the tube should be so placed that the heater pins are one atop the other, that is, their position is in a single perpendicular plane, in respect to each other. For the 6-volt or automotive series it is often recommended that these tubes may be used in any position.

Station Sparks

By Alice Remsen

NANCY NOLAND, a young personality singer from the South, who came North recently to seek a career in radio, is the third singer to achieve a microphonic debut via Ernest Cutting's popular program, "Airbreaks." Miss Noland was given a chance by Cutting and now has her own period each Monday at 9:30-45 a.m. over an NBC-WEAF network. Mary Phillips, who sings popular songs to her own piano accompaniment each Thursday at 12:00 noon over an NBC-WJZ network, and each Tuesday at 9:30 a.m. over an NBC-WEAF network, is also one of Ernest Cutting's discoveries. Bill Whitley, the first graduate of "Airbreaks," is heard on Mondays at 3:00 p.m., over an NBC-WEAF network. All three of these young artists came to the networks with considerable experience over local stations in their home towns, and were prepared to capitalize on their "airbreak" when they got it. . . . The Palmer House Promenade, featuring Ray Perkins as master of ceremonies, with Gale Page, contralto, Betty Brown, comedienne, and the Harold Stokes Orchestra, is now on the air for a half-hour at 9:30 p.m. each Tuesday over an NBC-WEAF network, from the NBC Chicago studios. . . . Edward Davies has joined the Eddie Duchin Orchestra in their tri-weekly broadcasts. Duchin has moved his band from the Central Park Casino, New York, to the Dells, in Morton Grove, near Chicago, and plans to remain there throughout the summer. The Duchin program, as before, will be heard each Tuesday, Thursday and Saturday at 9:30 p.m. over an NBC-WJZ network; still sponsored by the Pepsodent Company. . . . Have you heard the "Comedian Harmonists" from Berlin, Germany, now being featured in a series of programs over WEAF? They are Europe's most popular male singers of concert and jazz melodies. Twelve engagements will be fulfilled by these fine robust singers before they return to their native country. . . . The Gould-Shefter two-piano recitals over WJZ at 12:15 p.m. on Sundays is one of the brighter spots of the air-waves and should not be missed. . . . Countess Olga Albani is doing good work on the Cities Service program these Friday nights, while Jessica Dragonette is vacationing. . . .

The latest radio artist to trek Hollywood-wards is Frank Parker, the popular young NBC tenor, who will broadcast from there with the Jack Benny program. Frank has receiver film offers from various companies, and will probably make a picture while on the Coast. . . . Gladys Swarthout's new series is worth while; each Monday at 8:30 p.m. over an NBC-WEAF network, with William Daly's Orchestra and a vocal ensemble. Sponsored by Firestone. . . . Joe Cook has a new time now, Monday instead of Saturday night, and 9:30 p.m. instead of 9:00 p.m., WEAF. . . . Helen Menken made such a hit in appearances with the "Big Show" on CBS, that the sponsors have signed her for the rest of the current series. . . . Richard Himber, conductor of the Studebaker Champion, is quoted as saying: "Over-arranged music is doomed. Music must fulfill three objectives: it must be danceable, understandable and pleasant to listen to—and those are the things I take into consideration in arranging tunes for my programs." . . . And Lillian Roth, stage, screen and radio star, echoes my own sentiments when

she says: "I attach more importance to the lyrics of a song than to the music. The words should be imbued with the proper feeling and expression. I try to pick out numbers for my programs that are lyrically superior—songs whose words carry out a definite idea." . . . Maxine, young contralto, and Phil Spitalny with his orchestra and girl ensemble, have changed their time and day of broadcasting; they are now heard over the WABC-Columbia network at 8:00 p.m. each Wednesday instead of Friday. . . . Very glad to hear that Emil Velazco has started a series of broadcasts over WABC and network with his orchestra, from the grill of the Hotel Taft in New York; periods are Mondays, 1:00 p.m., Thursdays, 5:00 p.m., Fridays, 1:30 p.m., and Saturdays, 5:00 p.m. . . . The Ponce Sisters are still holding their own out in Cincinnati, broadcasting over the Nation's Station, WLW.

If you are anywhere in the vicinity of New York and can get WOR, listen to a new memory program, Sundays at 2:30. . . . Natalie Norman, popular soprano, has a new weekly series over Station WMCA, New York, which she calls "Beethovens of Broadway." Each program will be dedicated to an outstanding American composer; Sundays at 8:15 p.m. . . . Tom Noonan, the Bishop of Chinatown, gave his farewell performance for the season over WMCA recently. Harry Hirshfield, famous after-dinner speaker and wit, was one of the principal speakers on the program; Noonan will return to the air again in the Fall. . . . Nick Lucas is still going strong as crooning troubadour and gives a thrill to the addicts of emotional voices. . . . Henry Ford's program of melange is peppier each time. . . . Dramas are getting a big play.

FINANCIAL REPORTS

Radio-Keith-Orpheum Corporation (Subsidiary of R.C.A.) and Subsidiaries. The quarter ended March 31, 1934, shows a net profit of \$498,131 before deduction of Federal income taxes. The net profit after provision of \$75,000 for these taxes, amounted to \$423,131. For the same period in 1933, after elimination of operations of subsidiaries in bankruptcy or receivership, there was a net loss of \$1,098,447. This calculation of profit and loss included the full interest accrued on R-K-O's secured funded debt, but no interest accrued on the unsecured indebtedness after January 27, 1933, the date of the receivership. For the year 1933, the receiver's report of the R-K-O Corporation and subsidiaries, shows a net loss after taxes, interest, depreciation, loss on investments and capital assets, provision for losses of affiliated companies and other deductions, of \$4,384,064, as compared with a net loss for the year 1932, of \$695,503.

B. F. Keith Corp. (Controlled by Keith-Allbee-Orpheum Corp.)—Net profit for the quarter ended March 31, 1934, after depreciation and other charges, \$101,017, without provision made for Federal income taxes.

Marconi Wireless Telegraph Co., Ltd. (Controlled by Cables & Wireless, Ltd.)—Net income for 1933, £126,553, which, after preference dividend requirements, equals 5.40 per cent. on £2,020,133 ordinary combined shares of £1 and 10s par stock, against £74,735, or 2.83 per cent., on ordinary stock in 1932.

Magnavox Co., Ltd., and Subsidiaries—Net income for the year 1933, after depreciation, expenses, special development costs, etc., \$84,860, which equals 7 cents a share on 1,283,666 capital shares. For the year 1932 there was a net loss of \$233,845.

Noblitt-Sparks Industries, Inc.—For the four months ended April 30, 1934, net profit after Federal taxes and other charges, \$74,737, which equals 50 cents a share on 150,000 capital shares. In the same period last year there was a net loss of \$41,766.

Pathe Exchange, Inc., and Subsidiaries—Net profit for the three months ended March 31, 1934, after deduction of taxes, amortization, depreciation of properties, etc., but before interest charges, \$51,971, as compared with a net profit for the same period last year, of \$31,725. Both these periods include the regular quarterly dividend of \$49,000 on the 49 per cent. interest in the Du Pont Film Manufacturing Corp. Net profit for the three months ended March 31, 1934, was \$14,169, after interest on the funded debt and amortization of debenture discount and expenses. In 1933, for the three months ended April 1, there was a net loss, after these charges, of \$17,850.

Weston Electrical Instrument Corp. and Domestic Subsidiary—For three months ended March 31, 1934, net profit of \$43,979, after deduction of Federal taxes, depreciation and other charges, which equals, after \$2 Class A dividend requirements, 16 cents a share on 160,583 no-par common shares. For the first quarter of 1933 there was a net loss of \$47,298. A dividend of 50 cents a share on the Class A stock was declared by the Weston Electrical Instrument Company, because of accumulations which will amount to \$1 a share after this payment.

Two Almost for One

Radio World is \$6.00 a year (52 issues). Read the following Combination Offers for Radio World and other worth-while publications for one full year on each offer.

- RADIO WORLD and POPULAR SCIENCE MONTHLY \$6.50.
- RADIO WORLD and RADIO-CRAFT (monthly, 12 issues) \$6.50.
- RADIO WORLD and RADIO INDEX (monthly, 10 issues), stations, programs, etc., \$6.35.
- RADIO WORLD and RADIO (monthly, 12 issues; Short Wave and Experimental) \$6.60.
- RADIO WORLD and EVERYDAY SCIENCE AND MECHANICS (monthly) \$6.50.
- RADIO WORLD and RADIO LOG AND LORE. Bi-monthly; 5 issues. Full station lists, cross indexed, etc., \$6.25.
- RADIO WORLD and AMERICAN BOY — YOUTH'S COMPANION (monthly, 12 issues; popular magazine) \$6.50.
- RADIO WORLD and BOYS' LIFE (monthly, 12 issues) \$6.50.
- RADIO WORLD and MOTION PICTURE MAGAZINE (monthly) \$6.50.
- RADIO WORLD and MOVIE CLASSIC (monthly) \$6.25.
- RADIO WORLD and SCREENLAND (monthly) \$6.50.
- RADIO WORLD and SILVER SCREEN (monthly) \$6.25.
- RADIO WORLD and THE PATHFINDER (weekly) \$6.25.
- RADIO WORLD and TRUE STORY (monthly) \$6.50.
- RADIO WORLD and LIBERTY (weekly) \$6.50.

Select any one of these magazines and get it for an entire year by sending in a year's subscription for RADIO WORLD at the regular price, \$6.00 plus a small additional amount, per quotations above. Put a cross in the square next to the magazine of your choice, in the above list, fill out the coupon below, and mail the quoted price by check, money order or stamps to RADIO WORLD, 145 West 45th Street, New York, N. Y. (Add \$1.50 for extra foreign or Canadian postage for both publications.)

Your Name.....
 Your Street Address.....
 City..... State.....

**DOUBLE
VALUE!**

- If renewing an existing or expiring subscription for RADIO WORLD, please put a cross in square at beginning of this sentence.
- If renewing an existing or expiring subscription for other magazines, please put a cross in square at the beginning of this sentence.

RADIO WORLD, 145 West 45th Street, New York. (Just East of Broadway)

The Mascot "Two"

Three-Valve Performance, Using the 19

By Alexander G. Heller

Chief Engineer, Insuline Corporation of America

THE development of the multi-element tubes has had one great effect on radio design, namely, the simplification of receivers without sacrifice of sensitivity. As an example, consider the Universal Mascot, a two-tube short- and broadcast-wave receiver. It is functionally a three-tube circuit. The second tube is a 19, a new amplifier tube having two triode elements in the same envelope; and these two elements are connected in tandem in a resistance coupled amplifier. How this is done is seen on the circuit diagram, which is reproduced in Fig. 1 on opposite page.

In that figure the detector circuit is also shown in detail, and it is noticed that the detector tube is a 32. Since this is a screen grid tube with a high gain and a high detecting efficiency, a sensitive receiver is to be expected—a sensitive receiver with only two bulbs.

The sensitivity is increased at least a thousand-fold by regeneration in the detector circuit or may be when required, for it is closely controllable by means of a 2,000-ohm variable resistor in the plate circuit.

Plug-in Coils Employed

The universality of this receiver refers to the frequency coverage rather than to the usual power supply, for the coverage is from 19½ to 550 meters whereas the power supply is by batteries only. Such wide coverage cannot be obtained with a single coil, and for that reason some form of switching is necessary. A simple and rather unique method has been devised for this circuit. To understand construction let us first look at the photograph of the interior of the set (on front cover). In the center is what appears like a coil shield, as indeed it is. At the near end of this coil shield is mounted a six-contact socket, which is the receptacle for the coil.

Now let us examine Fig. 2, which is a

LIST OF PARTS

Coils

One set of 6-prong, plug-in coils (green, 16-38 meters; brown, 35-75 meters; black, 73-137 meters; red, 135-200 meters; and two for the broadcast band).

Condensers

C1—One 140 mmfd. variable condenser
C2—One 50 mmfd. variable condenser
C3—One 0.0001 mfd. grid condenser
C4—One 0.001 mfd. regeneration condenser
C5—One 0.001 mfd. by-pass condenser
C6, C7—Two 0.02 mfd. stopping condensers
C8, C9—Two one mfd. by-pass condensers
C10—One antenna condenser, 20-100 mmfd.

Resistors

R1—One one megohm grid leak
R2—One 50,000-ohm plate resistor
R3—One 5,000-ohm filter resistor
R4—One 100,000-ohm coupling resistor
R5, R6—Two 500,000-ohm grid leaks
R7—One 100,000-ohm filter resistor
One 0-2,000-ohm regeneration control
One 10-ohm rheostat

Other Requirements

One metal panel with escutcheon plates
One four-contact socket engraved "32"
One six-contact socket engraved "19"
One battery strip
One metal sub-panel
One pair phone tip jacks
One coil shield can with 6-contact socket
One rubber grommet
Necessary screws, washers, lugs, and hook-up wire
Four bakelite knobs
Two dial drive assemblies
Two condenser dial scales
One mounting bracket for five-plate condenser (50 mmfd.)
One grid clip

photograph of the panel of the receiver. In the middle of the panel is a circular device with a handle attached to it. This is attached to the plug-in coil and forms a metallic lid over the coil compartment. From the front at least, the coil is perfectly shielded and there can be no body capacity effects, provided that the panel and the chassis are grounded.

For covering the entire tuning range, six plug-in coils are required, two of which are for the broadcast band. These are variously colored for easy identification and they are also marked to indicate the range.

Tuning

The details of the tuner are shown on the circuit diagram, Fig. 1. In the antenna lead is a 20-100 mmfd. condenser. The importance of this condenser is so well known that it is not necessary to go into it. The tuner proper consists of two condensers in parallel, one of 140 mmfd. and another of 50 mmfd. The larger condenser serves merely as a coarse tuner whereas the smaller serves for fine adjustment and for band-spreading. Each condenser is represented on the panel by a knob and a dial. The smaller condenser is on the right, looking from the front, and the larger on the left.

Both dials are provided with slow motion drives, and precise tuning, therefore, is very easy.

Assembly

For those who cannot follow a circuit diagram in wiring the circuit, a picture diagram, Fig. 4, is on next page, showing distinctly every connection to be made, and so clearly that it is practically impossible to make a mistake. Further aid is obtained from Fig. 3, which is a reproduction of an actual photograph of the receiver as it appears under the panel. This picture and the one on the front cover show plainly the simplicity of the circuit.

Diagram on Opposite Page is Composed Like This

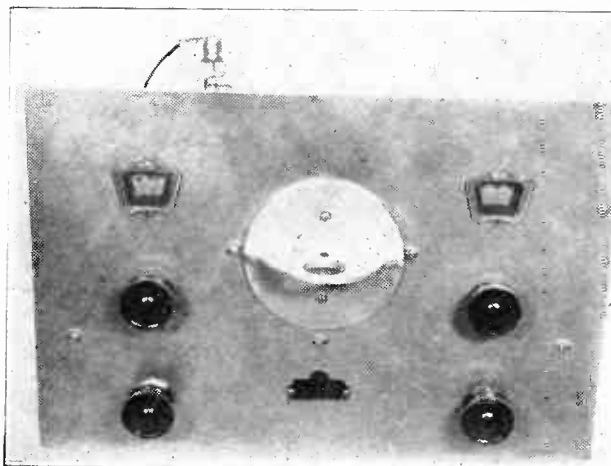

FIG. 2

Panel view of the Universal Mascot showing the arrangement of the controls and the location of the plug-in coil receptacle.

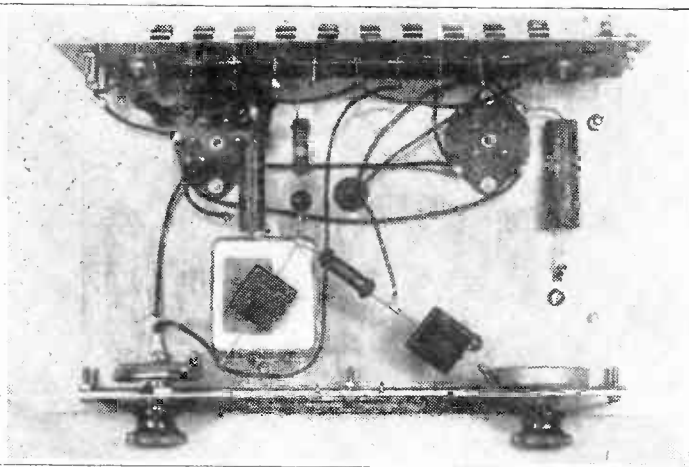

FIG. 3

Bottom view of the Universal Mascot showing the location of resistors and by-pass condensers. Simplicity of wiring is obvious.

Pictorial Diagram of the Short-Wave Mascot For Real Results With Only Few Parts

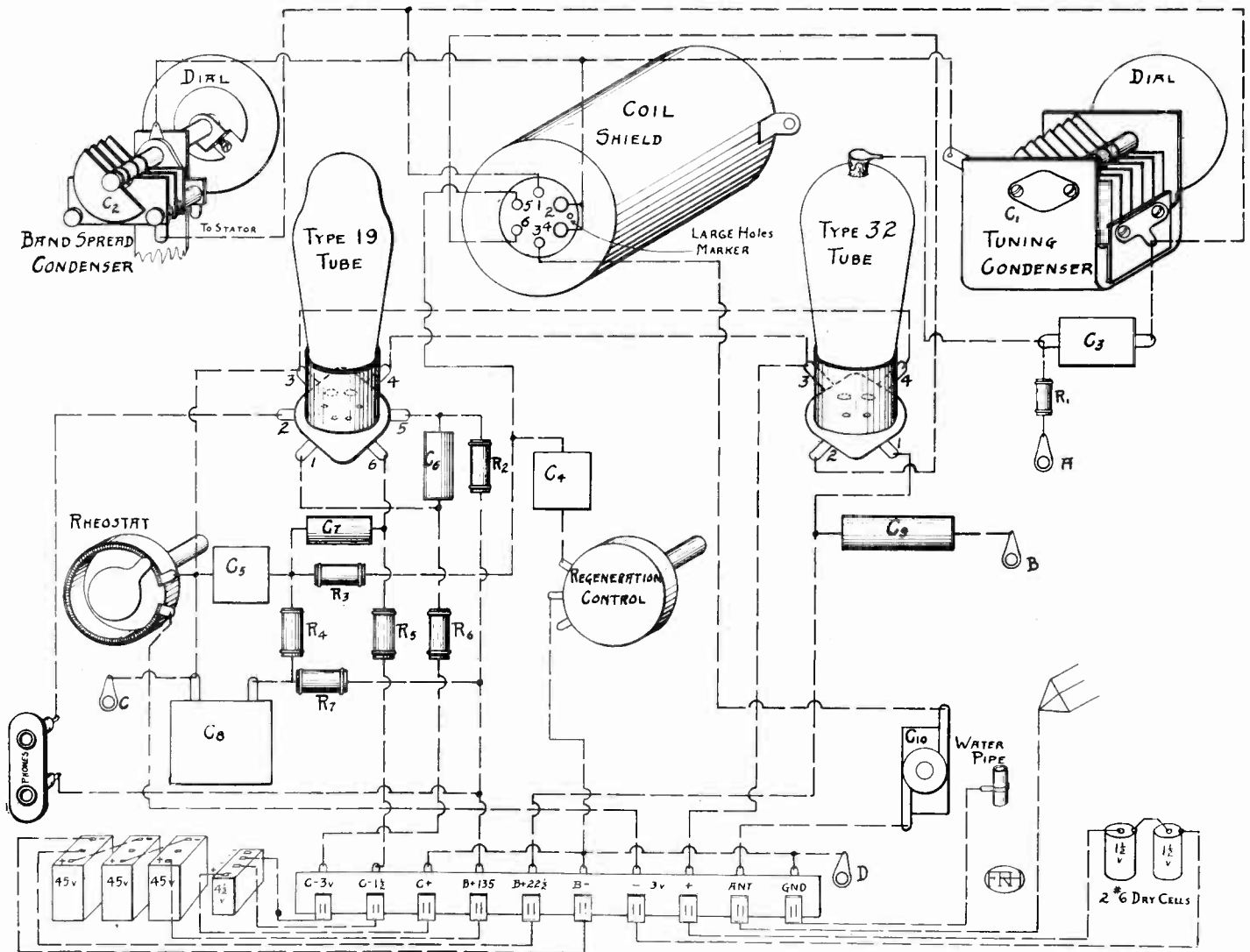

FIG. 4
The pictorial diagram of the Universal Mascot which shows exactly how the various connections should be made.

[Refer to the circuit diagram on Page 18 that corresponds to above]

Second Edition of Ladner and Stoner

Those who would learn the theory and present practice of short-wave radio communication will do well to study "Short-Wave Wireless Communication," by Ladner and Stoner, the second edition of which has just appeared, scarcely more than a year after the appearance of the first edition. The first was sold out because of its timely publication and the clearness and authority with which this comparatively new subject was treated. The second edition is assured of an even more favorable acceptance, for now the work is known to engineers and much new material has been added. As a text book the volume is concise

and lucid and easy to read. A small amount of mathematical knowledge is necessary to comprehend certain sections. As a reference work it is thorough, not only because of its own scope but also because the large number of references given to selected original sources. "It contains all about short waves that one needs," is the way one critic expressed his judgment of the book. That may be a bit too enthusiastic; but it does contain all that one need know of short-wave theory and practice to remove the handicap of a late start in the study of the subject and to put one in a position to follow intelligently present progress as it is disclosed in the technical press. The book is gaited to a fast pace and represents one of the best embodiments of radio technique between book covers.

A THOUGHT FOR THE WEEK

A BANJO is just a banjo to most people. It's a collection of strings that are agitated by busy but not always clever fingers. But there's Eddie Peabody's banjo. That's different—or at least Eddie's manipulation of the strings leads to something besides noise. Eddie has been one of America's greatest banjoists for some years and now he is demonstrating over the air that the banjo has possibilities not dreamed of by the average performer. His banjo has a place among the important instruments of the concert stage. A symphony number in which Eddie plays means something besides a name. Listen to him on WJZ, New York on Saturday night at 9 P.M., and see if the banjo isn't full of music you never knew was there before.